

TECHNICAL MANUAL

**OPERATOR'S AND ORGANIZATIONAL
MAINTENANCE MANUAL
[INCLUDING REPAIR PARTS AND SPECIAL TOOLS LIST]**

RADIO SET AN/PRC-47

WARNING

DO NOT store a charged or activated battery in Case, Radio Set CY-3700/PRC-47. Storage for a long period of time may allow hydrogen fumes from a battery to seep into Receiver Transmitter, Radio RT-671 /PRC-47. When the receiver-transmitter unit is removed from the case and energized, an explosion may occur. Any receiver-transmitter unit that is suspected of containing hydrogen fumes should be vented by removing Cover, Panel CW-647/PRC-47 and then removing the receiver-transmitter chassis from its case. Before stowing or shipping a radio set, the used batteries should be exchanged for unused batteries.

Operator and maintenance personnel should be familiar with the requirements of TB SIG 291 before attempting installation or operation of the equipment covered in this manual. Failure to follow the requirements of TB SIG 291 can result in injury or DEATH.

DEATH or SERIOUS injury may result from hazards in this equipment unless proper safety measures are observed when operating and maintaining the equipment. In addition to the 115- volt primary power source used in shelters, dc voltages to 1500 volts exist in the receiver-transmitter.

**OPERATOR'S AND ORGANIZATIONAL MAINTENANCE MANUAL
[INCLUDING REPAIR PARTS AND SPECIAL TOOLS LIST]**

RADIO SET AN/PRC-47

Current as of 22 April 1974

CHAPTER SECTION		Paragraph	Page
	1. INTRODUCTION		
	I. General		
	Scope	1-1	1-1
	Indexes of publications	1-2	1-1
	Forms and records... ..	1-3	1-1
	II. Description and data		
	Purpose and use	1-4	1-1
	Technical characteristics.....	1-5	1-2
	Items comprising an operable equipment	1-6	1-2
	Description		
CHAPTER SECTION	2. INSTALLATION		
	I. Service upon receipt of equipment		
	Siting instructions.....	2-1	2-1
	Shelter requirements	2-2	2-1
	Packaging data.....	2-3	2-1
	Unpacking instructions	2-4	2-1
	Checking unpacked equipment	2-5	2-4
	II. Installation instructions		
	Tools, test equipment, and materials required	2-6	2-4
	Assembly of component items	2-7	2-4
	Vehicular installation	2-8	2-5
	Power check	2-9	2-6
	Preparation of radio set for man/pack transportation.....	2-10	2-6
CHAPTER SECTION	3. OPERATION		
	I. Controls and indicators		
	Control panel	3-1	3-1
	Description of front panel controls, indicators, and receptacles.....	3-2	3-1
	II. Operation under usual conditions		
	General	3-3	3-3
	Preliminary starting procedures	3-4	3-3
	Receive operation	3-5	3-3
	Transmit operation	3-6	3-3
	Voice (usb) operation	3-7	3-4
	Telegraph (cw) operation	3-8	3-4
	Teletype (fsk) operation	3-9	3-4
	Remote control operation	3-10	3-4
	Tuning power amplifier	3-11	3-4
	Tuning with 50-ohm load	3-12	3-6
	Stopping procedures	3-13	3-6
	III. Operation under unusual conditions		
	General	3-14	3-7
	Operation in extreme cold.....	3-15	3-7
	Operation in tropical conditions	3-16	3-7
	Operation in desert conditions	3-17	3-7
	Emergency operation	3-18	3-7
	Operation during electronic jamming	3-19	3-7

*This manual supersedes TM 11-5820-509 - 12, 19 November 1963 and TM 11 5820 - 509-12P, 30 September 1963.

TM 11-5820-509-12

Section III (continued)		Paragraph	Page
	Antijamming techniques	3-20	3-8
CHAPTER	4. OPERATOR AND ORGANIZATIONAL MAINTENANCE		
SECTION	I. Operator's maintenance		
	Scope of operator's maintenance	4-1	4-1
	Materials required	4-2	4-1
	Operator's preventive maintenance.....	4-3	4-1
	Operator's preventive maintenance checks and services periods.....	4-4	4-1
	Daily preventive maintenance checks and services chart	4-5	4-1
	Cleaning	4-6	4-1
	II. Organizational maintenance		
	Scope of organizational maintenance	4-7	4-2
	Test equipment, tools, and material required.....	4-8	4-2
	Organizational maintenance.....	4-9	4-2
	Weekly maintenance	4-10	4-2
	Weekly preventive maintenance checks and services chart	4-11	4-2
	Quarterly maintenance.....	4-12	4-2
	Quarterly preventive maintenance checks and services chart	4-13	4-3
	Touch up painting instruction.	4-14	4-3
	III. Organizational troubleshooting		
	General	4-15	4-3
	Organizational troubleshooting chart.....	4-16	4-3
	Removal and replacement procedures	4-17	4-3
APPENDIX	A. REFERENCES		A-1
	B. BASIC ISSUE ITEMS LIST AND ITEMS TROOP INSTALLED OR AUTHORIZED LIST AND ORGANIZATIONAL MAINTENANCE REPAIR PARTS AND SPECIAL TOOLS LIST.		
SECTION	I. Introduction		B-1
	II. Basic issue items list (not applicable)		
	III. Items troop installed or authorized list (not applicable)		
	IV. Repair tools list		B-3
	V. Special tools list (not applicable)		
	VI. Federal Stock Number and Part Number (Not applicable)		
APPENDIX	C. MAINTENANCE ALLOCATION		
SECTION	I. Introduction		C-1
	II. Maintenance allocation chart		C-3

LIST OF ILLUSTRATIONS

Figure No.	Title	Page
1-1	Radio Set AN/PRC-47.....	1-0
1-2	Antenna AS-1320/PRC-47.....	1-6
1-3	Ac and dc power cables.....	1-6
1-4	Radio set rucksack frames.....	1-7
1-5	Case, Radio Set CY-3700/PRC-47.....	1-8
1-6	Receiver-Transmitter, Radio RT-671 /PRC-47.....	1-9
1-7	Radio set ground plane radial system placement	1-10
1-8	Radio set accessories.....	1-11
2-1	Packaging details, Radio Set Case CY-3700/PRC-47 (less electrolyte).....	2-2
2-2	Case, Radio Set CY-3700/PRC-47, packing details.....	2-3
2-3	Receiver-transmitter rucksack frame packing.....	2-7
2-4	Battery rucksack frame packing.....	2-7
3-1	Receiver-Transmitter, Radio RT-671 /PRC-47, front panel controls, indicators, and receptacles.....	3-1
3-2	Power amplifier load-tune chart.....	3-6
3-3	Power amplifier load and tune controls.....	3-6
B-1	Receiver-Transmitter, Radio RT-671/PRC-47, parts location	B-4

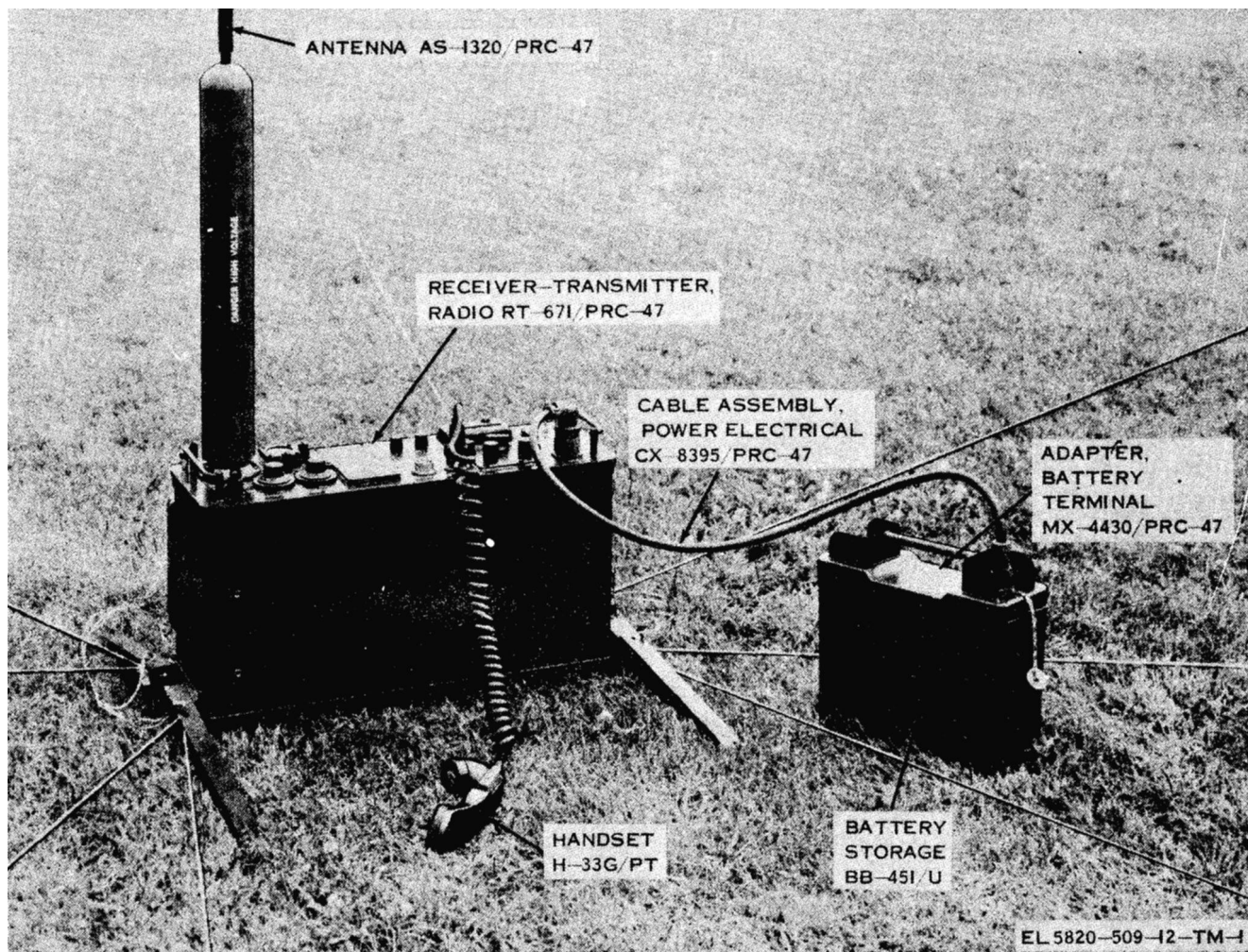

Figure 1-1. Radio Set AN/PRC-47

CHAPTER 1

INTRODUCTION

Section I. GENERAL

1-1. Scope

This manual describes Radio Set AN /PRC-47 (fig. 1-1) and includes instructions for installation, operation, organizational maintenance, shipment and limited storage, and demolition to prevent enemy use. The manual provides instructions for operation under usual and unusual conditions, and includes procedures for the cleaning, inspection, and maintenance of the AN/PRC-47 by the operator and organizational maintenance personnel. The repair parts list is contained in Appendix B and the maintenance allocation in Appendix C.

1-2. Indexes of Publications

a. DA Pam 310-4. Refer to the latest issue of DA Pam 310-4 to determine whether there are new editions, changes, or additional publications pertaining to this equipment.

b. DA PAM 310-7. Refer to DA Pam 310-7 to determine whether there are modification work orders (MWO's) pertaining to this equipment.

1-3. Forms and Records

a. Reports of Maintenance and Unsatisfactory Equipment. Maintenance forms, records, and reports which are to be used by maintenance personnel at all maintenance levels are listed in and prescribed by TM 38-750.

b. Report of Packaging and Handling Deficiencies. Fill out and forward DD Form 6 (Report of Packaging and Handling Deficiencies) as prescribed in AR 700-58/NAVSUP PUB 378/AFR 71-4/MCO P4030.29, and DSAR 4145.8.

c. Discrepancy in Shipment Report [DISREP] [SF 361]. Fill out and forward Discrepancy in Shipment Report (DISREP) (SF 361) as prescribed in AR 65-38/NAVSUPINST 4610.33/AFM 75-18MCO P4610.19A, and DSAR 4500.15.

d. Reporting of Equipment Manual Improvements. Report of errors, omissions, and recommendations for improving this publication by the individual user is encouraged. Reports should be submitted on DA form 2028 (Recommended Changes to Publications and Blank Forms) and forwarded direct to Commander, U.S. Army Electronics Command, ATTN: AMSEL- Fort Monmouth, NJ 07703.

e. Administrative Storage. For procedures, forms and records, and inspections required during administrative storage of this equipment, refer to TM 740-90-1.

f. Destruction of Army Materiel to Prevent Enemy Use. For information on this subject, refer to TM 750-244-2.

Section II. DESCRIPTION AND DATA

1-4. Purpose and Use

a. Purpose. Radio Set AN/PRC-47 (fig. 1-1) is a high frequency radio communications system. The radio set primarily provides 10,000 channels of upper sideband (usb) voice transmission and reception, continuous wave (cw) telegraphy, or frequency shift keying (fsk) teletype in the 2,000- 11,999-mHz frequency range. The radio set can be operated from its own control panel or controlled by a remote power control panel, such as Control Group AN/GRA-6, for at least a 2-mile distance.

b. Use. Radio Set AN/PRC-47 is used for two-way high-frequency (hf) radio communications. It is normally used in the portable (man carried) configuration,

but can be vehicular-mounted or used as a fixed station, such as in a shelter. In the portable configuration, one member of the two- team carries the receiver-transmitter, and the other member carries the battery pack and accessories. When the radio set is vehicular-power is supplied from the dc vehicular generator; when used as a fixed station, normal single-phase power is required. The radio set is also capable of frequency shift keying (fsk) communication when used in conjunction with the fsk converter such as Converter-Oscillator CV-786/TRC-75.

TM 11-5820-509-12

1-5. Technical Characteristics

Ambient temperature range.....	-40 CC (-40 °F) to +60°C.(+140°F).		
Ambient humidity range.....	0 to 100 percent relative.		
Altitude range	Sea level to 12,000 feet.		
Power source	With dc power supplies: 24 volt dc silver-zinc battery; 26.5-volt dc vehicular supply. With ac power supplies: 115 volts, single phase, 400 Hz.		dB with 2.0 microvolts rf input and 50 milliwatts minimum audio output.
Power consumption	Transmit: not more than 320 watts (Normal voltage, average power, voice operation). Receive: not more than 21 watts (at maximum battery voltage and with lights on).	Receive selectivity.	Response to signals from 300 to 3000 Hz above selected channel frequency not more than ±6 dB from response to signal 1700 Hz above selected channel frequency; response at least-60 dB at 4600 Hz above and 1000 Hz below selected channel frequency .
Duty cycle (battery.	High power: 1minute transmit 9 minutes receive for 1 hour Low power 2 minutes transmit 9 minutes receive or 10 minutes transmit. 5 minutes receive for 1hour.	Receive if. Rejection.....	At least 80 dB down
Frequency stability	±25 Hz for 60 days.	Receive image rejection.....	With reference to 5- input signals; 80 dB from 2.000 to 5.999 MHz, 60 dB from 6.000 to 9.999 MHz, 50 dB from 10.000 to 11.999 MHz.
Frequency range	2.000 to 11.999 mHz in 1. khz increments.	Receive agc characteristics	Maximum variation of 10 dB for input signals of 5 to 100,000 microvolts.
Harmonic spurious emission	Second harmonic at least 35 db down from transmission: all others at least 50 dB down from transmission output.	Receive audio output	At least 500 milliwatts for 1000-microvolt input.
Modes of operation.....	Usb only: voice, cw, or fsk, (modulating frequency is 800 Hz).	Receive audio distortion.....	Does not exceed 15 percent for 1000-microvolt rf input signal and 500-output signal.
Number of channels.....	10,000	Receive overall audio response.....	Within + 6 dB from 300 to 3000 Hz with reference to 1700 Hz.
Transmit power output (nominal into 50-ohm load).....	100 watts peak envelope power (high power).20 watts peak envelope power flow power).	Third order intermodulation products	At least 30 dB down.
Receive sensitivity.	Signal-plus-noise to noise ratio of at least 10	Transmit carrier suppression	At least 40 dB down.
		Undersired sideband rejection.....	At least 60 dB.

1-6. Items Comprising on Operable Equipment

a. *Components.* The components of the Radio set are listed in the following chart:

TM 11-5820-509-12

FSN	Qty	Item	Dimensions (in.)			Weight (lb)
			Height	Depth	Width	
5820-861-3539	1	Radio Set AN/PRC-47 consisting of:				
5820-082-1599	1	Receiver-Transmitter, Radio RT-671/PRC-47.	7	13 1/2	21 1/4	42
5985-087-2326	1	Antenna AS-1320/PRC-47--	180	---	---	4
5985087-2305	1	Antenna AS-1320/PRC-47--	540	---	---	2 1/2
6135-087-2301	1	Adapter, Battery Terminal MX-4430/PRC-47.	2 1/4	4	11 1/2	1 3/4
5820-970-6766	1	Adapter, Cable to Connector U-239/PRC-47	1 1/4	2	5	1/2
6140-889-1027	1	Battery, Storage BB-451/U (charged)	7 3/4	4 1/4	11 1/2	16
5995-087-2324	1	Cable Assembly, Power Electrical CX-8393/PRC-47	606	---	---	6 3/4
5995-082-0487	1	Cable Assembly, Power Electrical CX-8394 47	126	---	---	1 1/2
5995-087-2325	1	Cable Assembly, Power Electrical CX-8395/PRC-47	42	---	---	1/2
5995-087-2327	1	Cable Assembly, Special Purpose, Electrical, Branched CX-8396/PRC-47	55 1/2	---	---	1/2
5820-062-6748	1	Case, Radio Set CY-3700/PRC-47.	22 1/2	19 1/4	27 3/4	65
5965-243-6420	1	Dynamic Loudspeaker LS-166/U.	7	3	5	4
5965-163-9947	1	Handset H-33G/PT	70	---	---	1 1/4
5965-985-3589	1	Headset, electrical H-233/PRC-47	40	---	---	1 1/4
5820-062-4758	2	Legs, electrical Equipment MT-2786/PRC-47.	2	2	2	5 1/2
5805-171-3370	1	Telegraph Key J-45	5 1/2	---	---	1
5985-984-1774		Rucksack frame accessoried consisting of: Antenna case	24 1/2	2 1/2	4	1
5110-115-5049	1	Battery retainer	8	5	12	1
8105-766-1834	1	Canvas case	18	2 1/2	4	1
5820-987-8793	1	Rucksack	12	2 1/2	11 1/4	11 1/4
8465-558-0151	2	Rucksack frames	18	---	---	1

TM 11-5820-509-12

b. Running Spares. The chart below lists the running spares for the radio set. The two spare batteries are stored in the radio set case (fig. 2-2); the two fuses and the four lamps are stored inside the receiver-transmitter panel cover (fig. 1-6).

<i>FSN</i>	<i>Quantity</i>	<i>Item</i>
6140-889-1027	2	Battery, Storage BB-451/U
5920-280-3562	1	Fuse, cartridge: 20A, 125V, F03A125V20AS
5920-060-2424	1	Fuse, cartridge: 5A, 250V F02A250V5AS
6240-155-7836	4	Lamp ,incandescent: 28V, MS26237 -387

1-7. Description

Radio Set AN/PRC-47 (fig. 1-1) consists of several major units and a number of accessories that are required for operation. These major units are a receiver-transmitter, a silver-zinc battery, a power cable for battery (portable) operation that connects to a battery terminal adapter, a handset, and a whip antenna (fig. 1-2). In addition, an ac cable and a dc cable are provided for fixed station and vehicular operation respectively (fig. 1-3). The radio set is divided into two parts for portage; each part being attached to a separate rucksack frame for ease of handling (fig. 1-4). One frame carries the battery retainer and battery, battery cable, whip antenna, and accessory items required for portable operation. When desired to store the equipment, or when necessary to ship' the equipment, a radio set case (fig. 1-5) is provided. The case is waterproof and compartmentalized to protect the individual radio set units and accessories, and is equipped with carrying handles that permit easy handling. The radio set units and accessories are described below.

a. Receiver-Transmitter, Radio RT-671/ PRC - 47. Receiver-Transmitter, Radio RT-671/ PRC-47 (fig. 1-6) consists of an equipment chassis, an equipment case, and Cover, Panel CW-647/PRC-47.. With the panel cover secured to the unit, a waterproof assembly is obtained. Removal of this cover permits access to the front panel operating controls and receptacles of the RT-671/PRC-47. In normal operation, the panel cover is removed and stowed on the rear side of the RT-671/PRC-47, using the threaded fasteners that normally secure the RT-671/PRC- 47 case to the rucksack frame.

b. Battery, Storage BB - 51/U. Battery, Storage BB-451/U (fig. 1-6) is a 16-cell, silver- plate, wet electrolyte, 24-volt unit that is contained in a watertight glass filament-epoxy case, having a stainless steel cover plate. The battery consists of four replaceable mon-

oblock cases. Three batteries /two of them spares),shipped dry with electrolyte separate, form a normal complement for each radio set. The battery is normally supported in a battery retainer attached to the accessories rucksack frame for portable operation of the radio set. For further information on the battery, refer to TM 11-6140-208-16.

c. Adapter, Battery Terminal MX-4430/ PRC-47 (fig. 1-6). The MX-4430/PRC-47 furnished for use with, and fits on top of, the battery. The adapter includes a carrying handle and a receptacle to permit connection of Cable Assembly, Power Electrical CX-8395/PRC-47 for battery operation of the radio set. The adapter is keyed to fit on the battery only one way.

d. Antenna AS-1320/PRC-47. Antenna AS-1320/PRC-47 (fig. 1-2) is a 15-foot whip antenna that is used in conjunction with the ground-plane radials attached to Legs, Electrical Equipment MT-2786/PRC-47. The antenna is sectionalized into eight 20-inch sections plus a 20 inch threaded stud and is stowed in a canvas carrying case attached to the accessories rucksack frame (fig. 1-4).

e. Cable Assembly, Power Electrical CX-8395/PRC-47. Cable Assembly, Power Electrical CX-8395/PRC-47 (fig. 1-6) is a rubber insulated cable. The cable contains two conductors and is terminated in connectors (Bendix plugs) that permit interconnection of the receiver and the battery terminal adapter.

f. Antenna AS-1321/PRC-47. Antenna AS-1321/PRC-47 (fig. 1-8) is a sectionalized, rubber insulated, 45-foot long-wire antenna provided to improve the radiation efficiency of Radio Set AN/PRC-47 when it is operated in a less-than-desirable location, or when long communication paths are used. This antenna is equipped with an insulated endfitting adapter that permits connection directly to the front of the receiver-transmitter in the portable configuration. For mobile and fixed site application, the adapter is removed and connected to the existing antenna. Two strain insulators are strategically located along the length of the insulated conductor {at 15 and 25 feet) to permit coarse adjustment of radiator length to compensate for adjustments in transmitter operating frequency.

g. Cable Assembly, Power Electrical CX 8394/PRC - 47. Cable Assembly, Power Electrical CX-8394/PRC-47 (fig. 1-3) contains two conductors that permit interconnection of the receiver-transmitter and the vehicular power source. One end is terminated in a Bendix plug; the other end is terminated in two terminal lugs.

h. Cable Assembly, Power Electrical

CX-8393/PRC -47. Cable Assembly Power Electrical CX-8393/PRC-47 (fig. 1-3) contains two conductors that permit interconnection of the receiver-transmitter and a normal single-phase primary power source. No termination is provided on one end of this cable since some adjustment in cable length may be required for individual installations; the other end is terminated in a Bendix plug.

i. Legs, Electrical Equipment MT-2786/ PRC -47. Legs, Electrical Equipment MT-2786/ PRC-47 (fig. 1-6) are used in the portable application only. They provide support of the receiver-transmitter in an upright position and serve as mechanical connection points for the equipment end of the receiver-transmitter case and adjusted to level the equipment. The eight radials are then spread out to form a ground plane and their inner ends terminated on the ground posts of the receiver-transmitter. Figure 1-7 illustrates the configuration of the ground-plane radial system.

j. Handset H-33G/PT. Handset H-33G/PT (fig. 1-6) is a telephone-type assembly used for voice communications. It is equipped with a push to talk switch that is held closed during transmit periods but can remain open when receiving incoming signals.

k. Headset, Electrical H-233/PRC -47 and Telegraph Key J-45. Headset, Electrical H-233/PRC-47 and Telegraph Key J-45 (fig. 1-8) are used together during telegraph operation; the headset is worn on the head and the telegraph key is strapped to the leg. These items are connected to the front panel of the receiver- through Cable Assembly, Special Purpose, Electrical, Branched CX-8396/PRC-47.

l. Cable Assembly, Special Purpose, Electrical, Branched CX-8396/PRC - 47. Cable Assembly, Special Purpose, Electrical, Branched CX-8396/PRC-47 provides a connection to the receiver-transmitter for the headset and telegraph key (k above) when telegraph operation using the radio set is desired.

m. Dynamic Loudspeaker LS-166/U. Dynamic Loudspeaker LS-166/U (fig. 1-8) is an optional accessory that permits monitoring at the output of the

radio set without requiring continuous use of the handset or headset.

n. Case, Radio Set CY-3700/PRC -47. Case, Radio Set CY-3700/PRC-47 (fig. 1-5) is used to store and transport Radio Set AN/PRC-47. The compartmentalized metal carrying case provides storage space for all the major units and accessory items except for the electrolyte. A pressure relief valve is provided on the front of the case.

o. Adapter, Cable to Connector U-239/PRC-. Adapter, Cable to Connector U-239/PRC-47 (fig. 1-8) is used during fsk operation. An fsk converter (not provided) must also be used during this operation.

p. Rucksack Frame Accessories. These accessories consist of the following:

(1) Two rucksack frames (fig. 1-4) are provided: one used to carry the receiver transmitter the other to carry the accessories in (2) through (6) below.

(2) A rucksack secured to the frame to carry Cable Assembly, Power Electrical CX-8394/ PRC-47.

(3) A battery retainer, mounted beneath the rucksack, to carry the battery.

(4) An antenna case, strapped to one side of the rucksack, to carry dismantled Antenna AS-1320/PRC-47.

(5) A canvas case, strapped to the other side of the rucksack, to carry dismantled Legs, Electrical Equipment MT-2786/PRC-47.

(6) Assorted straps used with the rucksack frames.

q. Additional Equipment Required. In order for the radio set to be operated during the teletype (fsk) mode, a converter such as Converter-Oscillator CV-786/.TRC-75 (TM 11-5820-527-15) must be used; in order for the radio set to be operated by remote control, Control Group AN/GRA-6 (TM 11-5038) must be used.

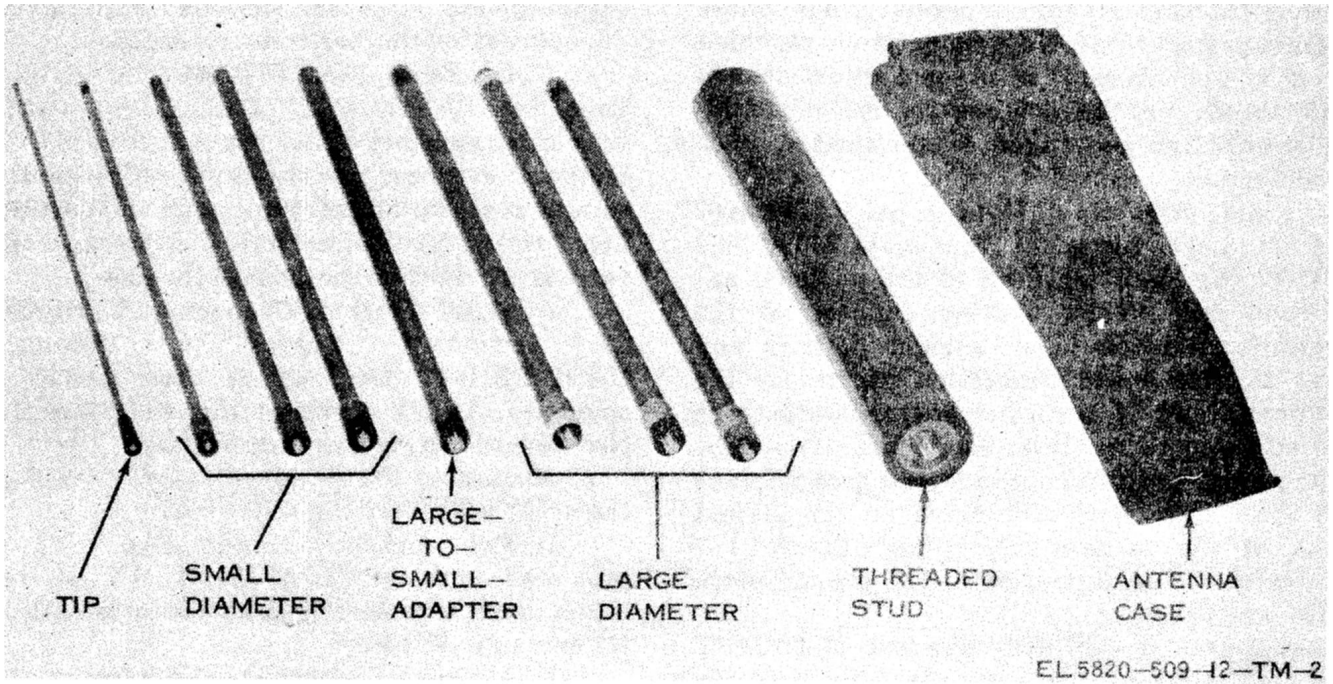

Figure 1-2. Antenna AS-1320 PRC-47

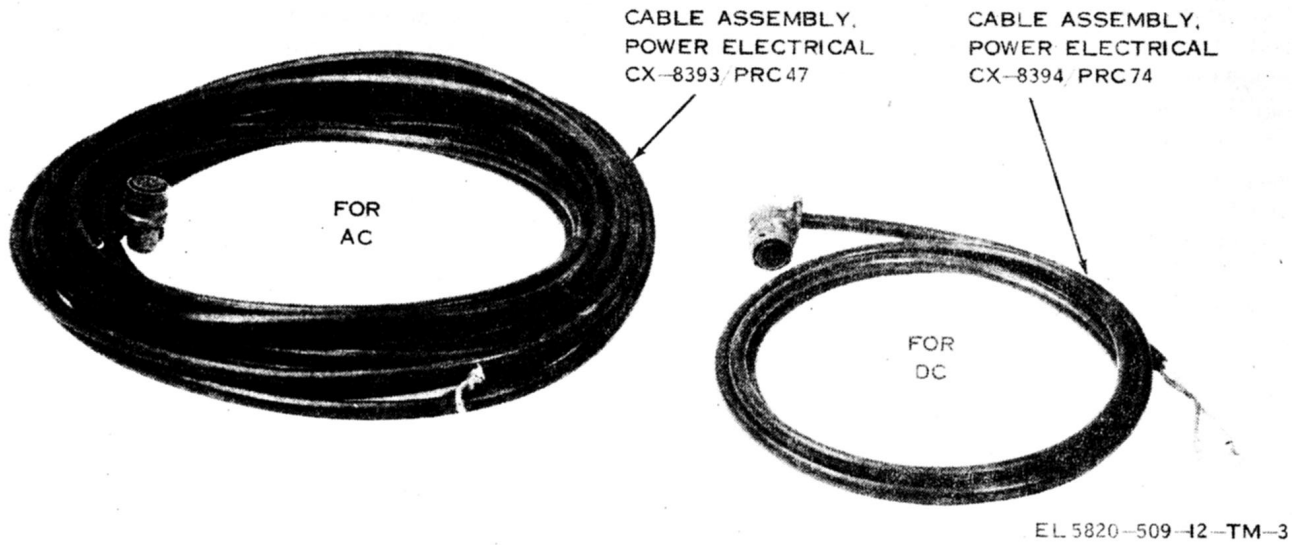
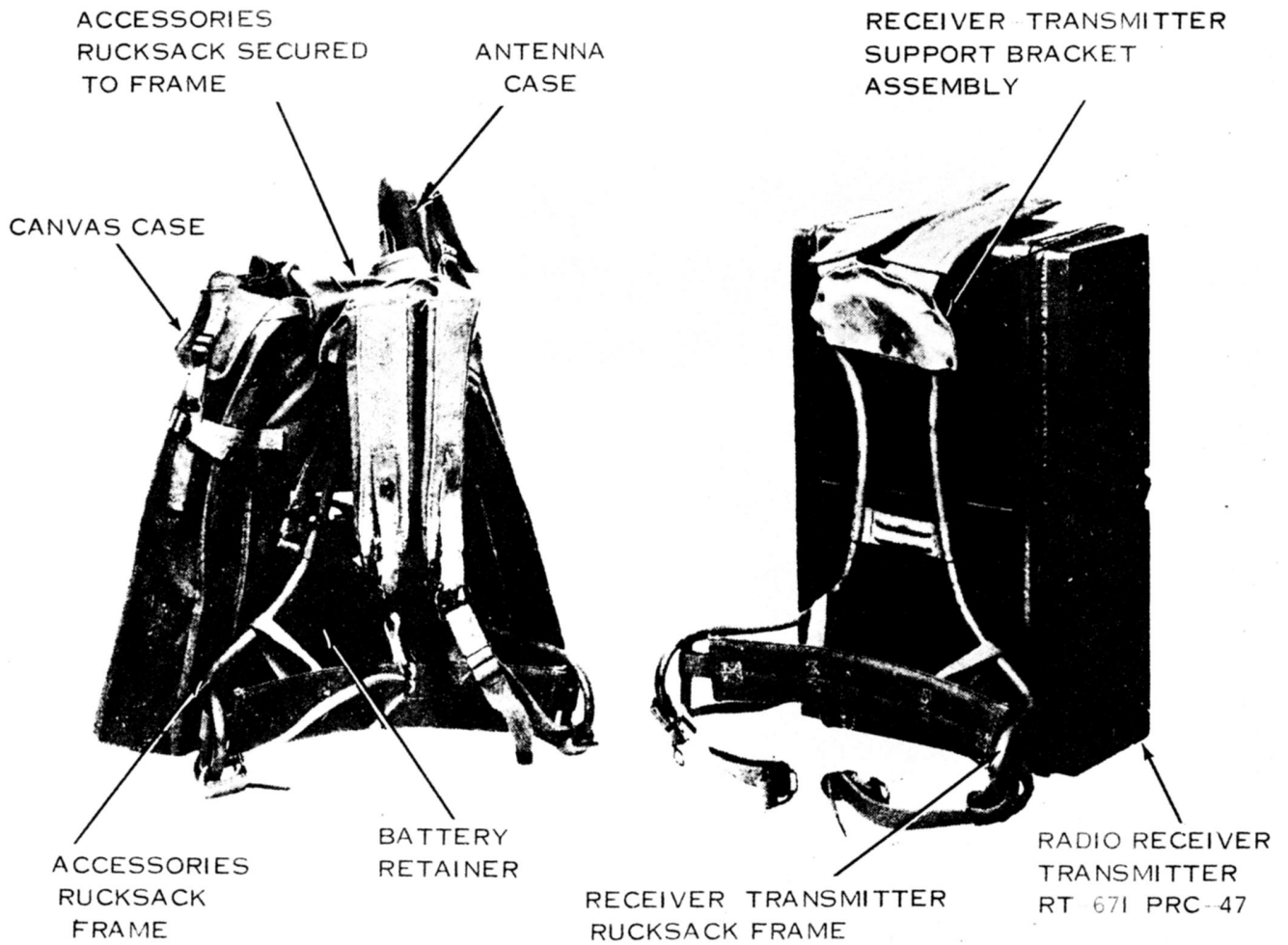
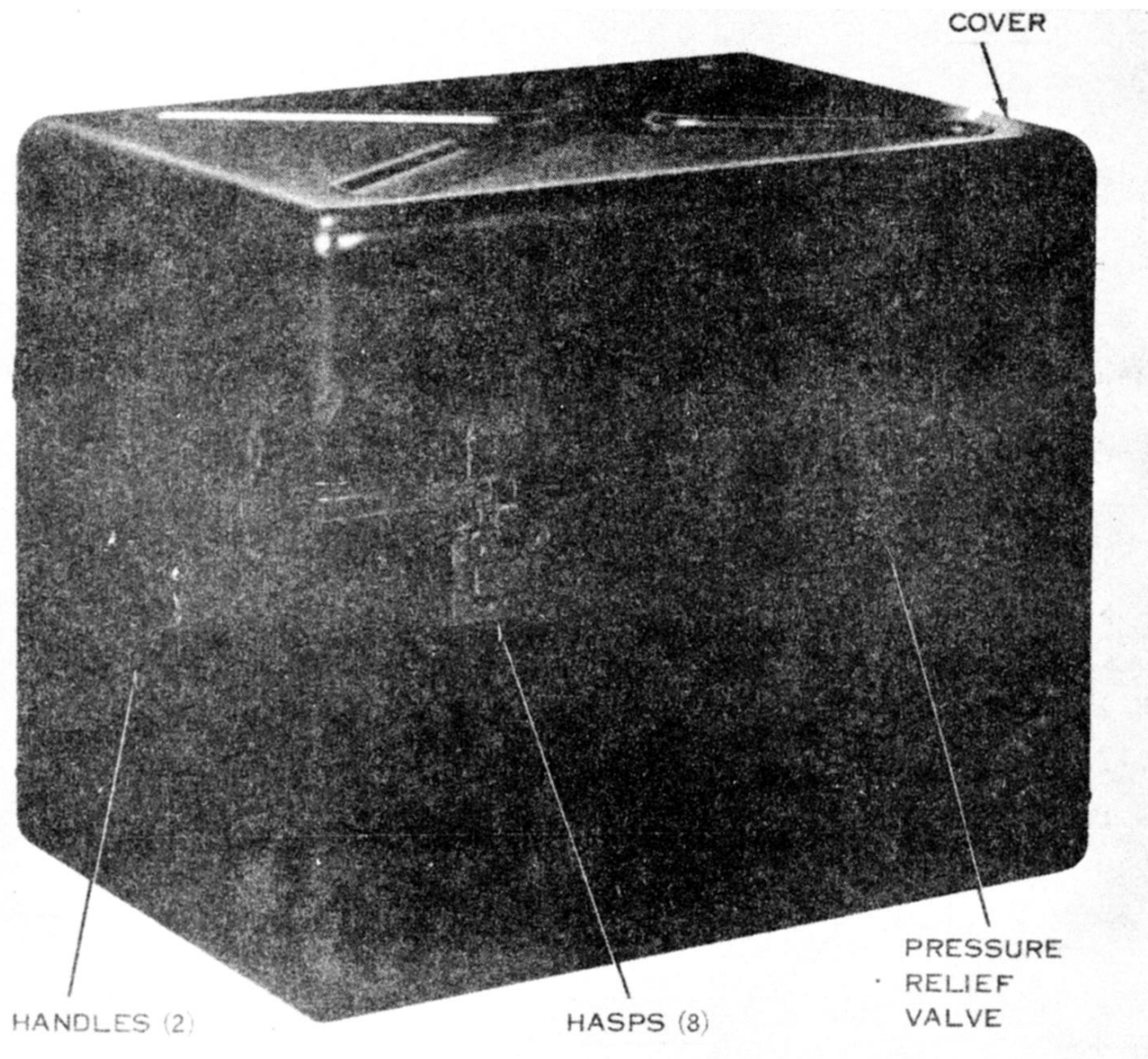

Figure 1-3. Ac and dc power cables.



EL5820 509 12-TM 4

Figure 1-4. Radio set rucksack frames.



EL 5820-509-12-TM-5

Figure 1-5. Case, Radio Set CY-3700/PRC-47.

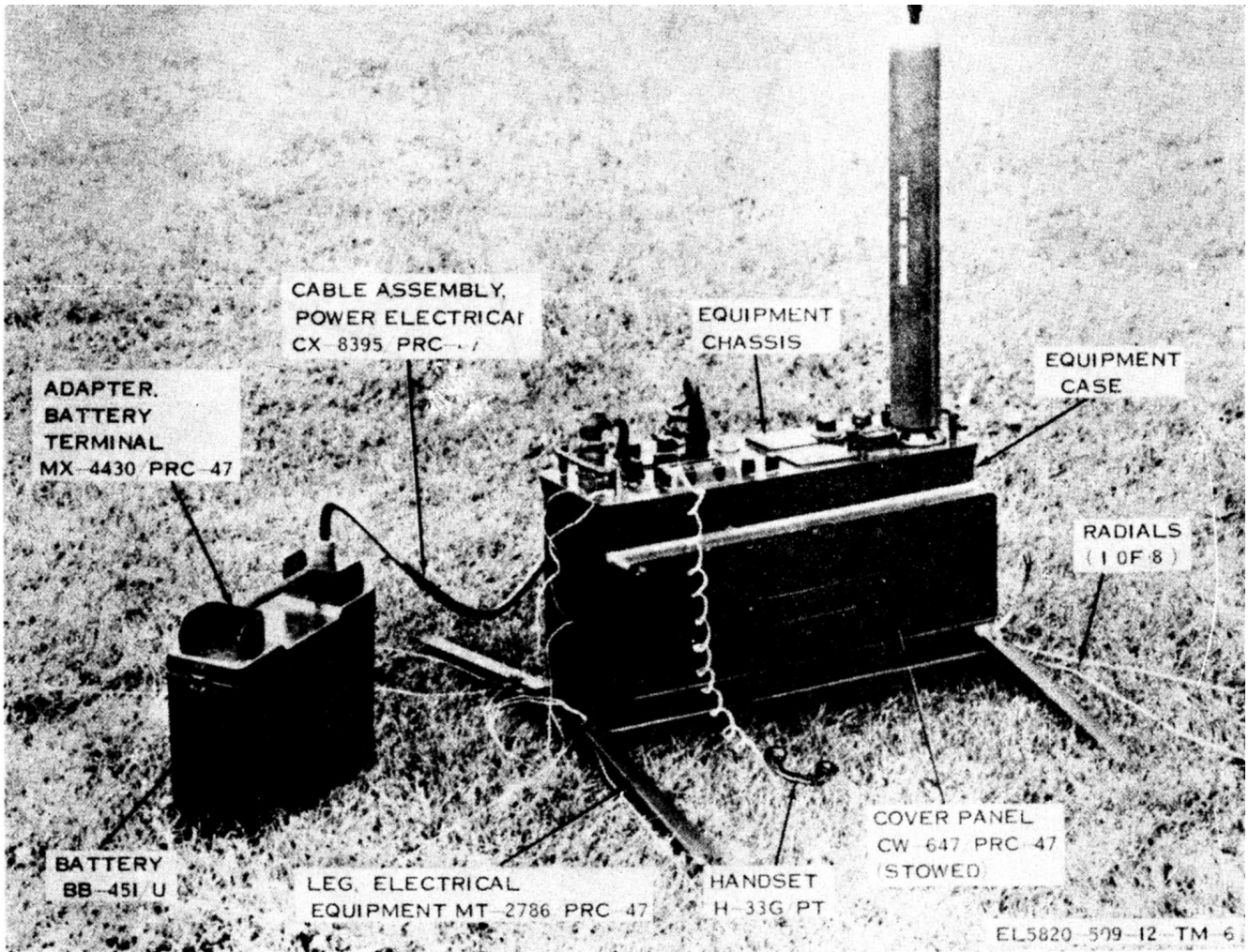

Figure 1-6. Receiver-Transmitter Radio RT-671/PRC-47.

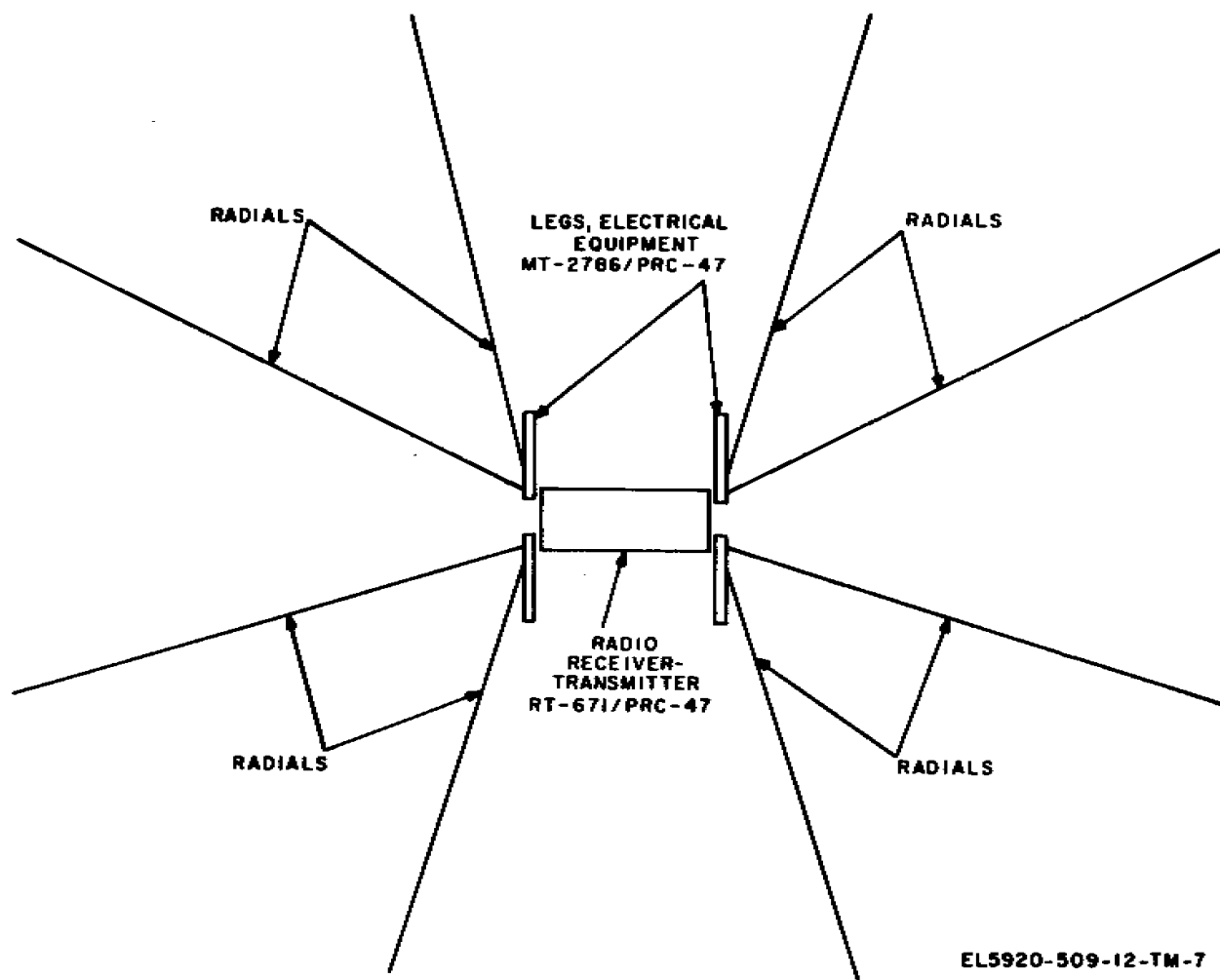

Figure 1-7. Radio set ground plane radial system placement.

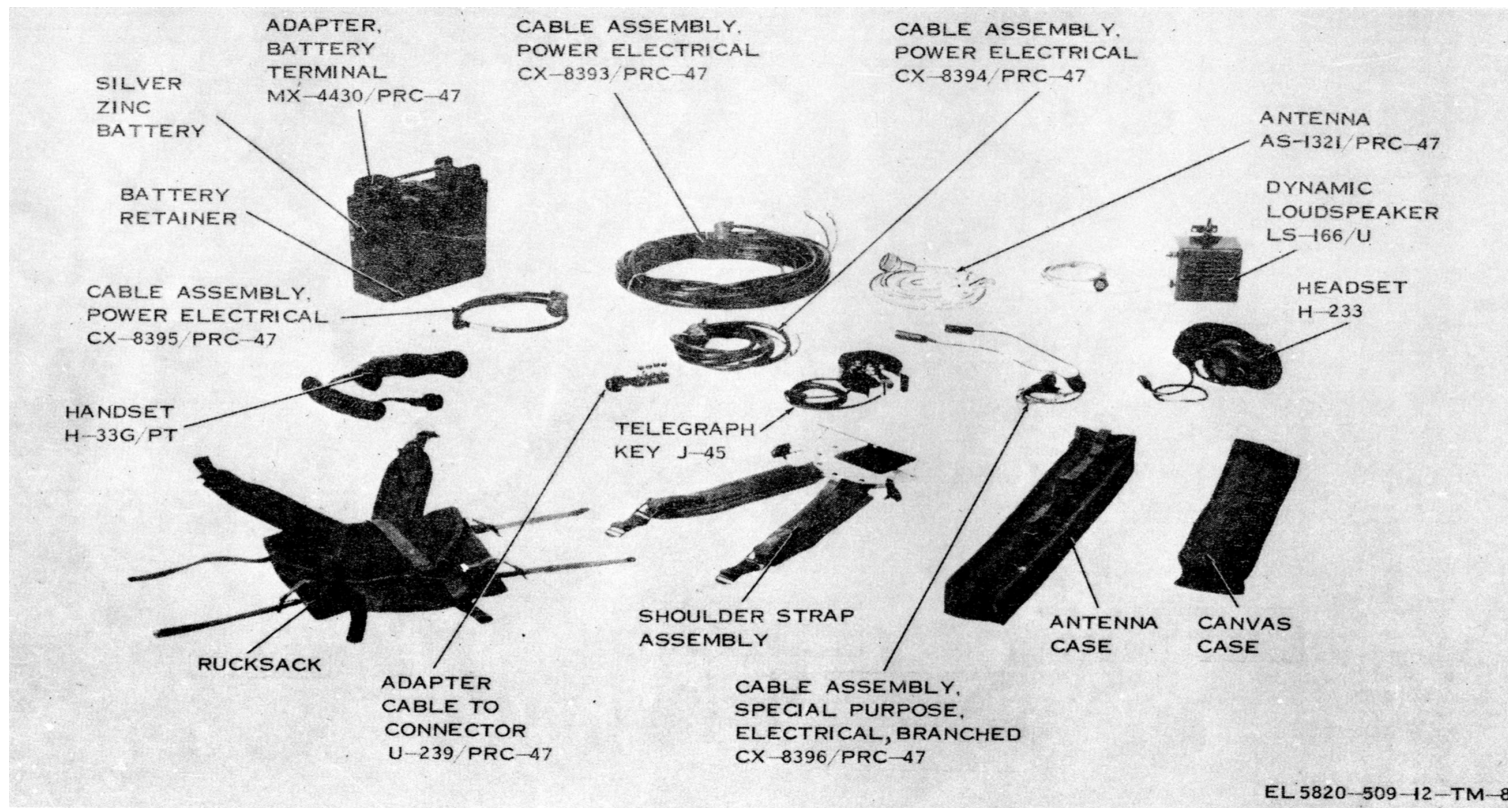

Figure 1-8. Radio set accessories.

CHAPTER 2

INSTALLATION

WARNING

During installation of this equipment, conform to all safety requirements set forth in TB SIG 291. Serious injury or DEATH can result from failure to comply with these safety practices.

Section I. SERVICE UPON RECEIPT OF EQUIPMENT

2-1. Siting Instructions

Some of the factors that must be taken into consideration when selecting a suitable operating site for a radio set installation are as follows:

a. When using the antenna-ground plane in the portable configuration, a site must be sufficiently clear of natural and manmade obstacles to permit all eight wire radials to be extended uniformly in all directions around the equipment for their entire length.

b. When the long-wire antenna is used, the selected site must have a clear area sufficiently large to accommodate the entire 45 feet of wire without coming near any metal objects. If point- to -point communication between fixed stations is planned, orient the antenna perpendicular to the path of transmission.

c. Transmitted signals have a greater range when the antenna site is as high as possible above surrounding objects. Avoid erection of the antenna or the transmitter site close to surrounding metal objects such as reinforced steel buildings, bridges, telephone or electric wire or cables, rail yards, or other large structures.

d. When omnidirectional operation is desired, place the antenna at the highest available location within the selected site. If the long-wire antenna is to be used, erect it as near to the vertical as possible.

e. Electrical interference may be avoided by choosing a site as far away as possible from powerlines, telephone lines, radar sites, and automobile highways.

2-2. Shelter Requirements

Since the radio set is watertight when Cover Panel, CW-647/PRC-47 is in place and remains splashproof when this panel cover is removed, no special shelter considerations are required. Because of the precision required in operating frequencies using single-sideband and teletypewriter modes, a modest amount of care should

be taken to operate the equipment in a clear, dry, cool area having as little vibration as possible. If internal maintenance is to be performed, a dust-free maintenance area is urged. Refer to paragraph 1-7 which provides all essential equipment dimensions necessary for installation.

2-3. Packaging Data

Radio Set AN/PRC-47 is packaged for shipment in two containers. The radio set carton (minus the electrolyte) is shown in figure 2-1. The electrolyte is packaged separately in a smaller carton and is referenced in TM 11-6140-208-15.

2-4. Unpacking Instructions

The receiver-transmitter assembly is shipped fully assembled with all fuses, vacuum tubes, modular subassemblies, and crystals installed. The battery is in the same container, but it is shipped without any electrolyte (dry charged). A separate container, suitably marked, is used to ship the potassium hydroxide electrolyte. Carefully unpack the radio set and its accessories as follows:

a. Unpacking Procedures, Radio Set Carton. Unpack the carton (fig. 2-1) containing the AN/PRC-47 as follows:

CAUTION

Open this carton carefully to avoid damage to equipment finish, packing material, and packing lists in the carton.

- (1) Place the carton in an upright position with the taped top clearly accessible.
- (2) Remove the tape from the lid, and open the carton.
- (3) Remove the top corner blocks, desiccant, and technical manuals.
- (4) Carefully lift Case, Radio Set

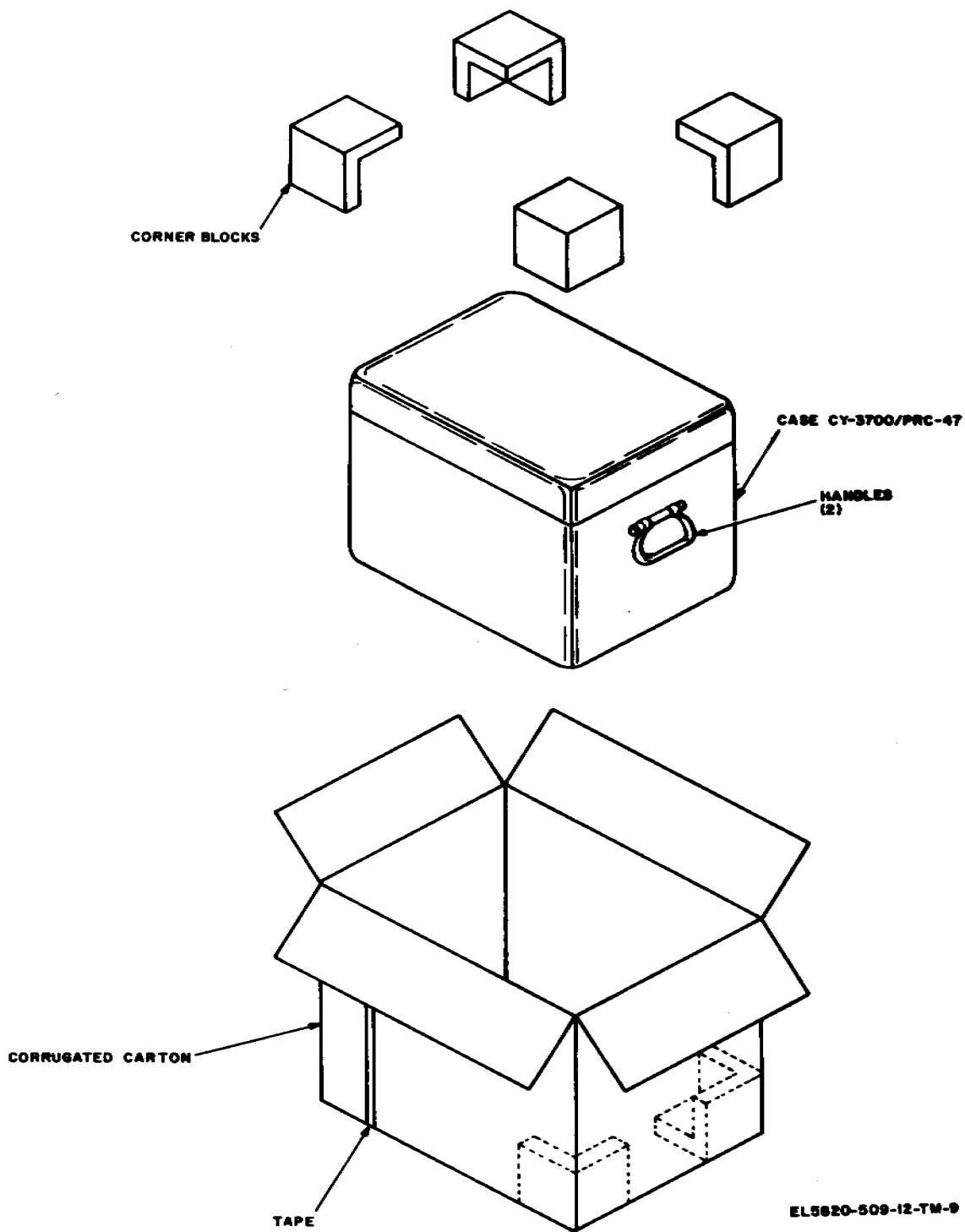

Figure 2-1. Packaging details, Radio Set Case CY-3700/PRC-47 (less electrolyte).

CY-3700/PRC-47 from its carton, by means of the two end handles, and place it in the work area.

b. *Unpacking Procedures, Case, Radio Set CY-3700/PRC - 47.* The case contains Receiver- Radio RT-671 /PRC-47 and all accessory items for the AN/PRC-47 except the battery electrolyte.

(1) Equalize the internal pressure by operating the pressure relief valve on the lower front of the CY-

3700/PRC-47 (fig. 1-6). Observe the instructions printed near this valve before operating.

(2) Loosen and remove the cover of the CY-3700/PRC-47 by operating the eight hinged hasps (two per side).

(3) Carefully lift the cover from the carrying case and invert.

(4) Cable Assemblies, Power Electrical

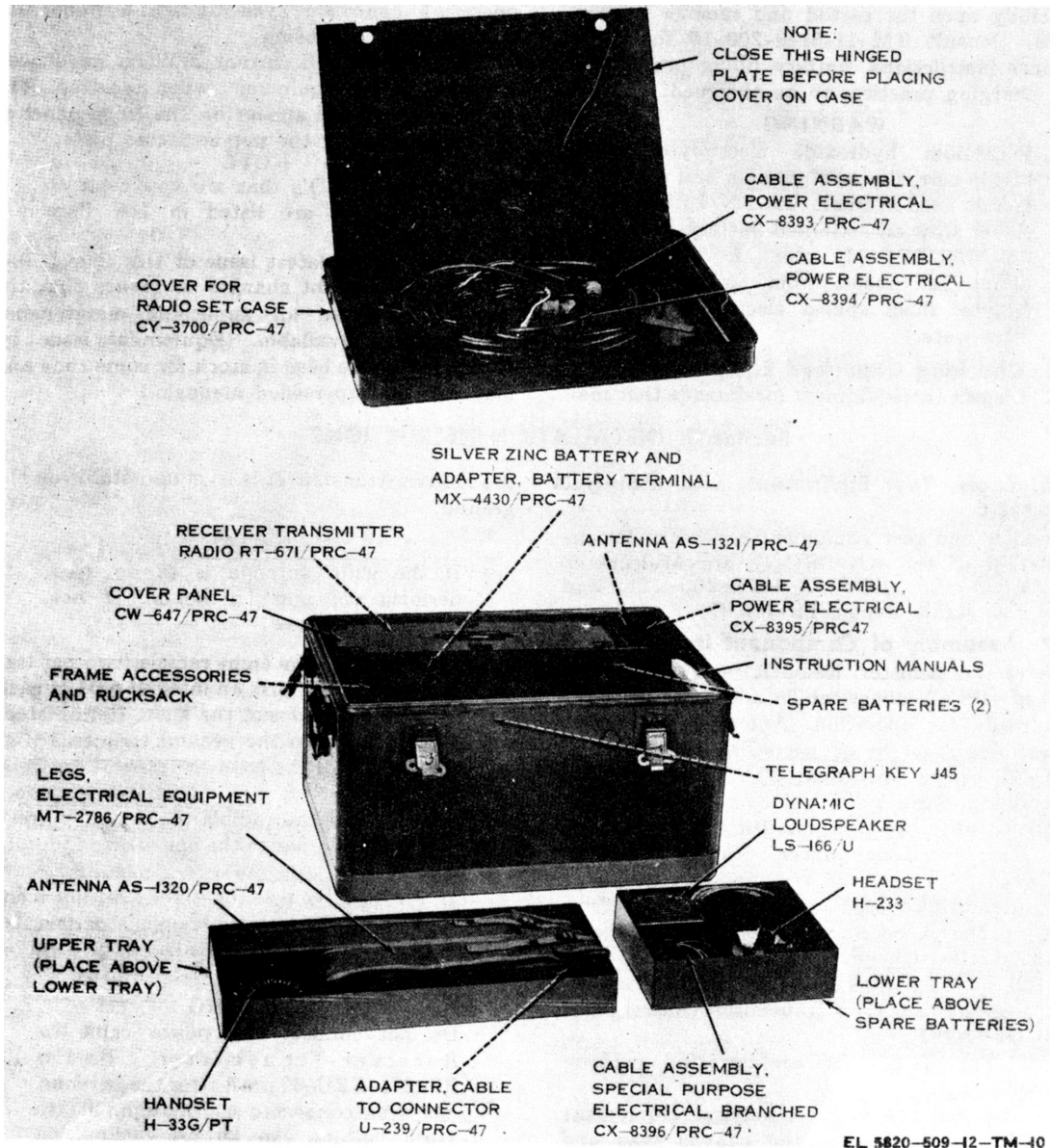

Figure 2-2. Case, Radio Set CY-3700/PR-7. packing details.

TM 11-5820-509-12

CX-8393/PRC-47 and CX-8394/PRC-47 are coiled inside the cover /fig. 2-2). Release the hinged plate by pressing the push-to-release fasteners.

(5) Remove individual items from the compartments within the CY-3700/PRC-47 as required.

c. Unpacking Procedures, Battery Electrolyte Carton. This carton is marked KIT, ELECTROLYTE FILLING FSN 5122-000-1069. Carefully open the carton and remove its contents. Consult TM 11-6140-208-15 for maintenance instructions, battery filling procedures, and charging practices to be observed.

WARNING

Potassium hydroxide electrolyte is highly corrosive to aluminum and other metals used in Radio Set AN/PRC-47. Never stow an activated battery in the CY-3700/PRC-47 case. A personal injury can result from spilled electrolyte; flush spilled electrolyte with clear water.

2-5. Checking Unpacked Equipment

a. Inspect the equipment for damage that may have occurred during shipment. If damage is evident, complete

and forward DD Form 6 (para 1-3 b).

b. Check the packing list against the equipment received to assure that all equipment is available. If a packing list is not available, check the equipment received against paragraph 1-6. Report all discrepancies in accordance with the instructions contained in paragraph 1-3 *b* or *c*. Always place the equipment in service if it is in operating condition even though a minor inventory part is missing.

c. Verify that all current MWO's have been installed in the equipment when received. The MWO number will appear on the front panel of the radio set near the nomenclature plate.

NOTE

Current MWO's that are applicable to AN/PRC-47 are listed in DA Pam 310-7.

d. Consult the latest issue of DA Pam 310-4 and its most recent changes to assure that the latest editions of all applicable maintenance literature are available. (Equipment issue by depots may have been in stock for some time and may contain superseded manuals.)

Section II. INSTALLATION INSTRUCTIONS

2-6. Tools, Test Equipment, and Materials Required

The tools and test equipment necessary for installation of the AN/PRC-47 are Multimeter AN/URM-105 (TM 11-6625-203-12) and Tool Kit, Radio Repair TK-115/G.

2-7. Assembly of Component Items

Receiver-Transmitter, Radio RT-671/PRC-47 is packed with all subassemblies and parts installed and ready for operation. Antennas and other accessories must be connected to the RT-671/PRC-47 before operation.. The procedures for assembling these individual components to the receiver-transmitter are detailed below.

a. Receiver-Transmitter, Radio RT-671/PRC - 47.

(1) Remove Cover, Panel CW-647/PRC-47 by means of the six fasteners and secure it to the side of the receiver-transmitter case (fig. 1-6).

(2) Be sure the POWER/LIGHTS switch (fig 3-1) on the Receiver-transmitter control panel is at OFF/OFF.

(3) For the portable configuration, perform the following:

(a) Remove Legs, Electrical Equipment MT-2786/PRC-47 from the canvas case and attach the legs to each end of the receiver transmitter. Adjust the legs individually so that

the receiver-transmitter is level and stable on the ground.

NOTE

If the whip antenna is to be used, perform (b) and (c) below. If not, perform (4) below.

(b) Unwind the eight radials (two per leg) from the spools that form an integral part of each leg (fig. 1-6) and connect the short (terminated) end of each radial to the ground terminals (fig. 3-1) at each end of the receiver-transmitter front panel.

(c) Extend the radials to form a pattern around the unit similar to the one shown in figure 1-7.

(4) For the vehicle or fixed station configuration, place the receiver-transmitter on a flat surface. If no flat surface is available, perform (3) *(a)* above.

WARNING

Do not connect any power cable to Receiver-Transmitter, Radio RT-671/PRC-47 until after the antenna has been connected to the equipment. High voltage can be present at the ANTENNA terminal that could cause personal injury or death

b. *Antenna Installation.* Two antennas are furnished with the radio set; Antenna AS-1320/ PRC-47 (whip) and Antenna AS-1321 /PRC-47 (long wire). The long-wire antenna is normally more efficient for transmission in the 2- to 9-MHz range; the whip antenna is most efficient in the 9.000- to 11.999-MHz range.

CAUTION

When the receiver-transmitter is mounted on a vehicle, do not use the whip antenna. Connect the receiver' transmitter to the vehicle antenna, since the ANTENNA terminal insulator on the front panel can be broken if an obstruction strikes the whip antenna while the vehicle is in motion.

(1) *Antenna AS-1320/PRC47.* Install the whip antenna as follows:

(a) Remove antenna elements from antenna case (fig. 2-2).

(b) Assemble the antenna before attaching it to the Receiver-transmitter Begin assembly from the large-diameter diameter threaded stud and work toward the tip section (fig. 1-2).

CAUTION

Tighten the mast sections with the fingers only; the use of pliers or other gripping tools can damage the mast sections.

(c) Attach the threaded stud section to the ANTENNA connection on the front of the receiver-transmitter (fig. 3-1).

(2) *Antenna AS-1321/PRC -47.* Install the long-wire antenna as follows:

(a) Remove the antenna from the case (fig.2-2).

(b) Connect the end adapter to the ANTENNA connection on the front of the receiver transmitter

(c) Set up the long-wire antenna on masts or attach it to a tree or building. Use insulation to prevent grounding.

NOTE

The antenna should be set up as high as possible for efficient operation.

(d) Use the jumpers to select the correct antenna length for the operating frequency: 45 feet for 2 to 5 MHz, 25 feet for 2 to 9 MHz, and 15 feet for 2 to 12 MHz.

(e) if convenient, the long-wire antenna may also be clamped to the exposed connector of one of the lower sections of the AS-1320/PRC-47 instead of attaching the adapter directly to the ANTENNA connector.

(3) *Vehicle and fixed station.* To set up either a vehicle or fixed station antenna, use the following procedure:

(a) Remove the antenna and adapter. Connect the antenna adapter to the ANTENNA connector on the receiver-transmitter control panel.

CAUTION

The overall length of the lead-in and the antenna should not exceed the lengths in paragraph 3-11c for the operating frequency.

(c) Connect the antenna lead wire to the vehicle or fixed station antenna.

c. *Connecting Primary Power.* Installation of each of the three power cables for the applicable configuration is described below:

(1) *Portable.* During portable operation, the primary power source is the battery. For this configuration, install Adapter, Battery Terminal MX-4430/PRC-47 on top of the battery. Note that the adapter is keyed for one-way installation only. Place the connector portion of the adapter on the same side as the + and - stampings on the battery. Attach Cable Assembly, Power Electrical CX-8395/PRC-47 to the connector on top of the adapter before connecting the opposite end to the POWER connector on the RT-671/PRC47 front panel (fig. 3-1). Proceed to paragraph 2-9a.

(2) *Vehicle.* When the primary power source is a dc generator, be sure that the instructions in paragraph 2-8 have been implemented. Connect Cable Assembly, Power Electrical CX-8394/ PRC-47 to the source and then to the POWER connector on the RT-671/PRC-47 front panel (fig. 3-1). Proceed to paragraph 2-9c.

(3) *Fixed station.* When 115-volt, 400-Hz, single-phase power is used for the radio set, use Cable Assembly, Power Electrical CX-8393/ PRC-47 to interconnect the powerlines with the RT-671/PRC-47. Proceed to paragraph 2-9 c.

2-8. Vehicular Installation

When the receiver-transmitter is used in vehicles, a special installation kit (which includes mounting facilities) must be procured. The kit (Installation Kit, Electronics Equipment MK-1519/PRC-47) is listed in SB 11-131.

TM 11-5820-509-12

2-9. Power Check

a. Battery Power. When battery power is used, proceed as follows:

(1) On receiver-transmitter, set POWER/LIGHTS switch (fig. 3-1) to ON/LO.

(2) Press BATTERY TEST pushbutton and check that XMTR OUTPUT meter indicates in white area. If meter indicator does not deflect, check that 20A DC POWER fuse is not defective. If the fuse is defective, replace it.

(3) If fuse is not defective, check cable CX-8395/PRC-47. If cable is defective, replace it.

(4) If meter indicator deflects, but not in white area, check the battery (open-circuited) with the multimeter. The multimeter should indicate at least + 29.2 volts dc. If not, substitute another battery and repeat these procedures. For the defective battery, refer to TM 11-6140-208-15.

(5) Set POWER/LIGHTS switch to OFF/ OFF.

b. Dc Generator Power. When a dc generator or vehicular power is used, proceed as follows:

(1) Repeat *a*(1) and (2) above.

(2) If fuse is not defective, check cable CX-8394/PRC-47. If cable is defective, replace it.

(3) If meter indicator deflects but not in white area, check the power source with the multimeter for 26 volts dc + 3.

(4) Set POWER/LIGHTS switch to OFF/ OFF.

c. Ac Power. When ac power is used, proceed as follows:

(1) Repeat *a*(1) and (2) above, except check 5A AC fuse.

(2) If fuse is not defective, check cable CX-8393/PRC-47. If cable is defective, replace it.

(3) If meter indicator deflects, but not in white area, check the power source with the multimeter for 115 volts ac +10.

(4) Set POWER/LIGHTS switch to OFF/ OFF.

2-10. Preparation of Radio Set for Man/Pack Transportation

The radio is attached to rucksack frames for man/pack transport. The receiver-transmitter is carried on one frame, and the battery and accessory items are carried on the other frame.

a. Packing Receiver-Transmitter, Radio RT-671 /PRC-47.

(1) Be sure the POWER/LIGHTS switch (fig. 3-1) is at OFF/OFF.

NOTE

If the radio set has just been unpacked, proceed directly to (6) below.

(2) Disconnect power and audio cables from the receiver-transmitter front panel.

(3) Disconnect the antenna (whip or wire), disassemble (or roll) it carefully, and store it in its own antenna case (fig. 2-41).

(4) Replace Cover, Panel CW-647/PRC-47 on the front of the receiver-transmitter and secure the six fasteners. Retain the four large screws.

(5) Remove Legs, Electrical Equipment MT-2786/PRC-47 from the receiver-transmitter and carefully wind the wires on their spools. Place the legs in the canvas case.

(6) Assemble the shoulder strap billets, quick-release fasteners, and the back strap (fig. 2-3) to the frame.

(7) Attach the support plate assembly to the shoulder strap assembly with two screws, washers, and nuts.

(8) Assemble the shoulder strap assembly to the top of the frame by pushing down on the top curve and snapping it in place.

(9) Secure the support plate assembly to the case of the receiver-transmitter, using two large screws used for stowing the panel cover to the case. Chain the large screws to the support plate assembly, using two small screws, washers, and nuts.

(10) Secure the bottom of the frame to the receiver-transmitter, using the two other large screws through the nylon clamps.

(11) Mount the assembled pack on the man's back; adjust the shoulder straps for comfort.

b. Packing Battery, Storage BB-451/U and Accessories.

(1) Repeat *a*(6) above.

(2) Connect the hook on the battery retainer under the crossmember of the frame and secure the retainer to the frame, using two screws and two nylon clamps (fig. 2-4).

(3) Install the battery on the battery retainer and secure it in place with the strap provided.

(4) Place the rucksack and shoulder strap assembly on top of the frame and snap it in place. Run the two straps at the base of the shoulder strap assembly under the battery retainer through the two buckles on the battery retainer, pull tight, and secure.

(5) Secure the canvas case containing the electrical legs to the right side of the rucksack.

(6) Secure the antenna case to the left side of the rucksack.

(7) Mount the assembled pack on the man's back; adjust the shoulder straps for comfort

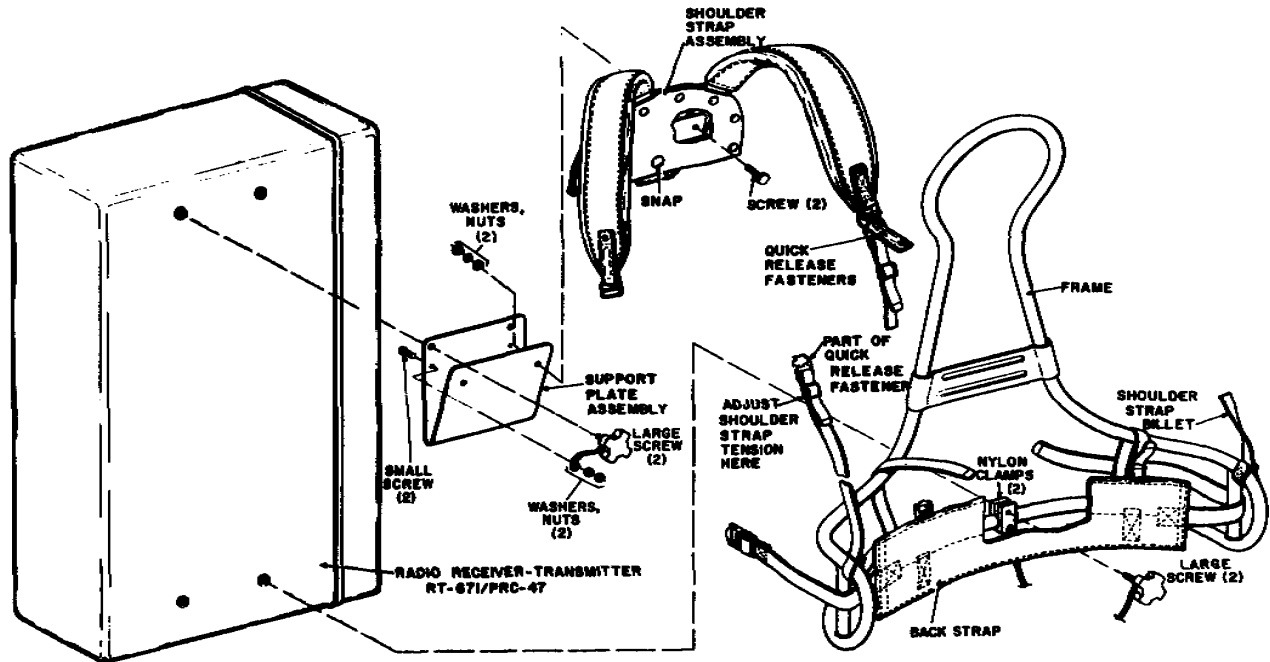

EL5820-509-12-TM-11

Figure 2-3. Receiver transmitter rucksack frame packing.

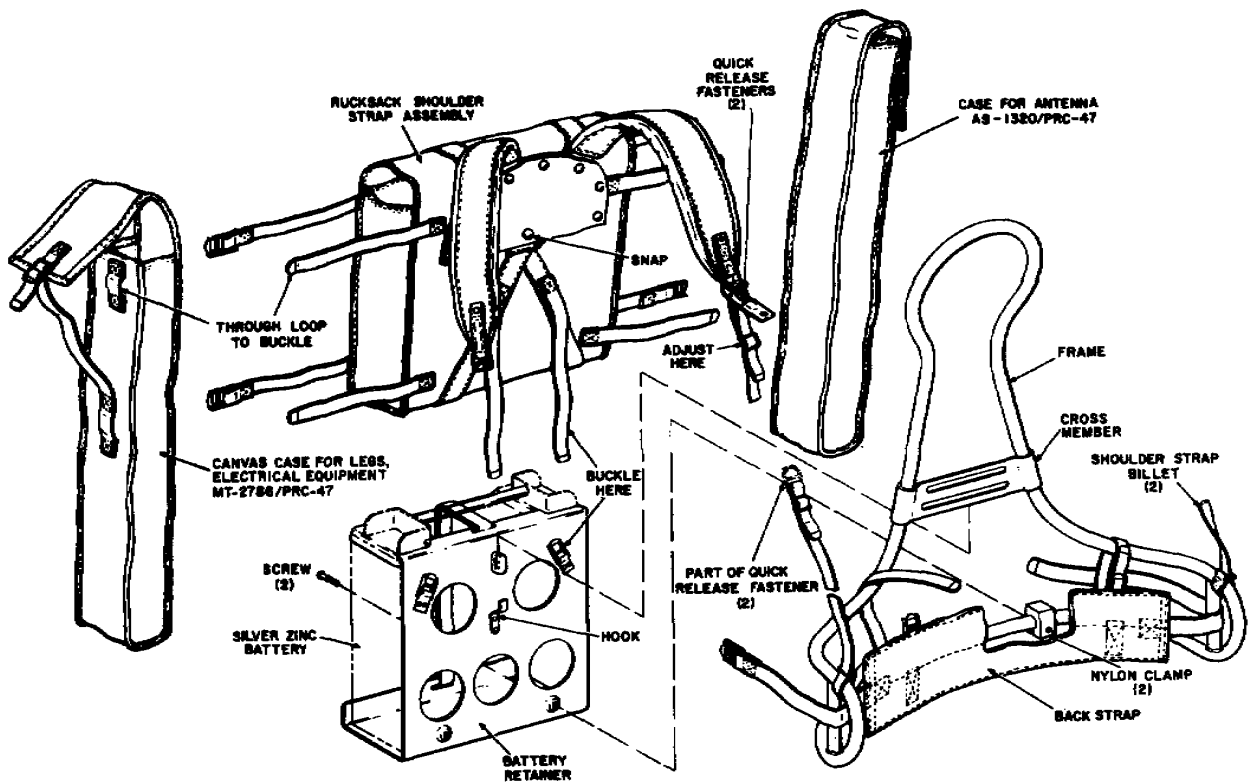

EL5820-509-12-TM-12

Figure 2-4. Battery rucksack frame packing.

CHAPTER 3

OPERATION

WARNING

Before operating this equipment, make sure that all requirements of TB SIG 291 are satisfied. Injury or DEATH can result from improper or careless operation.

Section I. CONTROLS AND INDICATORS

3-1. Control Panel

All controls, indicators, and receptacles used by the operator are located on the front panel of Receiver-Transmitter, Radio RT-671 /PRC-47. The front panel controls and indicators are illustrated in figure 3-1 and described in detail in paragraph 3-2.

3-2. Description of Front Panel Controls, Indicators, and Receptacles.

Each panel-mounted control or indicator (fig. 3-1) is listed in the following chart and a functional description is provided to assist the operator in the proper performance of his duties.

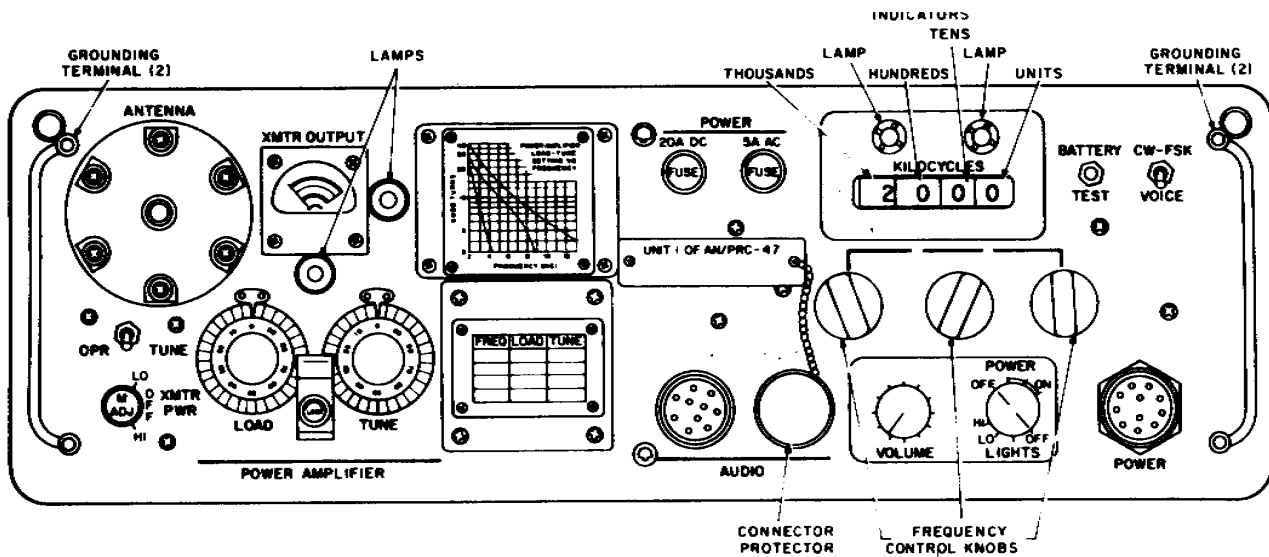

Figure 3-1. Receiver-Transmitter, Radio RT-671/PRC -7, front panel controls, indicators, and receptacles.

Control, indicator, or receptacle	Function	Control indicator, or receptacle	Function
ANTENNA connector	Threaded fastener in bowl insulator to which whip antenna, long-wire antenna, or vehicular antenna lead-in wire is individually attached.		
XMTR OUTPUT meter	Performs two functions: during tuning of the power amplifier, optimum adjustment of POWER AMPLIFIER LOAD and POWER AMPLIFIER TUNE controls results in maximum needle deflection of this meter; when BATTERY TEST pushbutton is pressed, and a power source is connected to the radio set, indicates (white area) whether input power is within tolerance.		
		POWER 20A DC fuse	A 20-ampere cartridge-type fuse that protects the primary power source circuit when a dc input is connected to the receiver-transmitter POWER connector.

Control, indicator, or receptacle	Sw pos TUNE	Function
		During radio set tuning, the high voltage supply is directly enabled by this switch.

Control, indicator or receptacle	Function
Indicators (4).....	Two lamps illuminate the Kilocycles indicator, one additional lamp illuminates POWER AMPLIFIER LOAD and POWER AMPLIFIER TUNE controls, and another lamp illuminates the XMTR OUTPUT meter.

Section II. OPERATION UNDER USUAL CONDITIONS

3-3. General

NOTE

Condensed operating procedures are provided on the back of the panel cover and may be used during emergencies.

Radio Set AN/PRC-47 provides voice (usb), telegraph (cw), or teletypewriter (fsk) communications. To operate the receiver-transmitter properly, perform the following procedures:

- a. Preliminary starting procedures (para 3-4).
- b. Receive operation (para 3-5).
- c. Transmit operation (para 3-6).
- d. Voice (usb) operation (para 3-7).
- e. Telegraph (cw) operation (para 3-8).
- f. Teletypewriter (fsk) operation (para 3-9).
- g. Remote control operation (para 3-10).
- h. Tuning the power amplifier (para 3-11).
- i. Tuning with 50-ohm load (para 3-12).
- j. Stopping procedures (para 3-13).

3-4. Preliminary Starting Procedures

The following initial adjustments and control settings are made before connecting power to the receiver-transmitter.

- a. Set POWER/LIGHTS switch (fig. 3-1) to OFF /OFF.
- b. Set XMTR PWR switch to OFF.
- c. Set OPR-TUNE switch to OPR.
- d. Rotate M ADJ control fully cw and then turn it back about a quarter turn from its stop.
- e. Rotate VOLUME control about halfway clockwise.
- f. Set CW-FSK/VOICE switch to VOICE.
- g. Connect the antenna system to the receiver- in accordance with paragraph 2-7b.
- h. Connect Handset H-33G/PT (or any other audio input/output device) to the AUDIO connector on the receiver-transmitter front panel.
- i. Depending on the mode of operation, connect the appropriate power cable to the primary power source (para 2-7 c) and then attach the other end of the cable to POWER connector on the receiver- front panel.

3-5. Receive Operation

CAUTION

To conserve battery power, use panel

lamps only when necessary.

- a. Set POWER/LIGHTS switch (fig. 3-1) to ON/LO and allow a minimum of 5 minutes for stabilization.
- b. Press BATTERY TEST pushbutton, and observe that XMTR OUTPUT meter indicates in white area of the scale.
- c. Adjust three frequency control knobs on receiver transmitter front panel for desired operating frequency indication in KILOCYCLES window.
- d. Adjust VOLUME control to provide comfortable listening level.

NOTE

Clear reception is occasionally hampered by spurious noises (birdies) occurring at the top three channels of each MHz band (2.997 MHz, 2.998 MHz, and 2.999 MHz for example). This condition is normal for the radio set.

3-6. Transmit Operation

Receiver Transmitter, Radio RT-67 1 /PRC-47 is operated as a transmitter by performing the following procedures.

WARNING

Do not touch the antenna above the threaded stud while transmitting. Serious injury or DEATH can result.

- a. Set POWER/LIGHTS switch (fig. 3-1) to ON /LO and allow a minimum of 5 minutes of stabilization.
- b. Press BATTERY TEST pushbutton and observe that XMTR OUTPUT meter indicated in white area of the scale.

NOTE

If the operating frequency must be changed, perform c below.

- c. Adjust three frequency control knobs on receiver-transmitter front panel for desired operating frequency indication in KILOCYCLES window.
- d. Perform the procedures of paragraph 3-7 if voice (usb) operation is desired; paragraph 3-8 below if telegraph (cw) operation is desired; paragraph 3-9 below if teletypewriter (fsk)

TM 11-5820-509-12

operation is desired.

3-7. Voice [Usb] Operation

Place the front panel controls as follows:

a. Verify that CW-FSK/VOICE switch (fig. 3-1) is at VOICE.

b. For transmission/reception, connect Handset H-33G/PT to either AUDIO connector on the receiver-transmitter front panel. If only reception is desired, Dynamic Loudspeaker LS-166/U may be connected to the AUDIO connector.

CAUTION

During portable operation, use LO power setting whenever possible to conserve battery power.

c. Set XMTR PWR switch to LO for low power operation, and to HI for high power operation.

d. Press push-to-talk button on handset and wait 1 second before start of message. Whenever reception is desired, release push-to-talk button. Adjust VOLUME control for comfortable listening level during receive periods.

e. If the transmitting frequency must be changed, adjust the frequency control knobs as in paragraph 3-6c, repeat a through d above, and then perform paragraph 3-11. If a 50-ohm antenna is used, proceed to paragraph 3-12.

3-8. Telegraph [Cw] Operation

Adjust the front panel controls as follows:

a. Set the CW-FSK/VOICE switch (fig. 3-1) to CW-FSK for both reception and transmission; set the switch to VOICE for reception only.

b. Connect Cable Assembly, Special Purpose, Electrical Branched CX-8396/PRC-47 to either AUDIO connector on receiver-transmitter front panel.

c. Insert the connectors of Headset H-233/PRC-47 and Telegraph Key J-45 into the mating connectors in the branched end of Cable CX-8396/PRC-47.

CAUTION During portable operation, use LO power setting whenever possible to conserve battery power.

d. Set XMTR PWR switch to LO for low power operation, and to HI for high power operation.

e. Adjust VOLUME control for a comfortable listening level during receive periods.

f. If the transmitting frequency must be changed, adjust the frequency control knobs as in paragraph 3-6 c, repeat a through e above, and then perform paragraph 3-11. If a 50-ohm antenna is used, proceed to paragraph 3-12.

3-9. Teletype [Fsk] Operation

When the radio set is operated in the fsk mode, a teletypewriter and a converter-oscillator (both not supplied) must be obtained. Converter-Oscillator CV-786/PRC-47 (TM 11-5820-527-15) is recommended, or any other converter that uses 2425-MHz (mark) and 1875-MHz (space) frequencies. For the fsk mode, make the following connections:

a. Mount Adapter, Cable to Connector U-239/PRC-47 (fig. 1-8) to either AUDIO connector on the receiver-transmitter front panel (fig. 3-1).

b. Connect the output of the teletypewriter to the converter-oscillator and the output of the converter-oscillator to the wire connectors on Adapter U-239/PRC-47.

c. Set the CW-FSK/VOICE switch (fig. 3-1) to CW-FSK for both reception and transmission; set the switch to VOICE for reception only.

CAUTION

When battery is being used, use LO power setting whenever possible to conserve power.

d. Set XMTR PWR switch to LO for low power operation, and to HI for high power operation.

e. If the transmitting frequency must be changed, adjust the frequency control knobs as in paragraph 3-6c. Repeat a through e above, and then perform paragraph 3-11. If a 50-ohm antenna is used, proceed to paragraph 3-12.

3-10. Remote Control Operation

For remote control operation, proceed as follows:

a. Connect Control Group AN/GRA-6 (TM 11-5038) to either AUDIO connector (fig. 3-11) on the receiver-transmitter front panel.

b. Set all operating controls on the front panel in accordance with preceding instructions for mode of operation desired. The AN/GRA-6 is then used to control the power function only.

3-11. Tuning Power Amplifier

When the transmitter portion of the receiver- is to be used, the power amplifier and the antenna system must be resonated to the operating frequency to assure maximum radiation of the rf signal and to prevent damage to the power amplifier output circuits.

CAUTION

When the transmitting procedures direct the operator to this paragraph, be sure to perform each of the following procedures in the sequence listed to assure proper loading.

a. Set XMTR PWR switch (fig. 3-1) to OFF.

- b. Set OPR/TUNE switch to TUNE.

CAUTION

Do not allow the power amplifier to remain keyed for more than a few seconds at a time while tuning, since excessive dissipation tends to burn out the vacuum tubes and serious damage can result to components of the output circuit.

c. Refer to figure 3-2 which is the same chart that is on the receiver-transmitter front panel. On POWER AMPLIFIER LOAD and POWER AMPLIFIER TUNE controls (fig. 3-3), loosen lock knobs. Adjust the turns counters of the controls to the settings indicated on the LOAD TUNE chart as follows. The outer scale of each turns counter is numbered in units from 0 to 39 and represents the whole-number part (coarse tuning) of the turns count shown on the LOAD- chart (fig. 3-2). The inner scale of each turns counter (fig. 3-3) is numbered from ~ to 100, and this scale makes 1 complete rotation per outer scale unit division. The inner scale represents the decimal part (fine tuning) of the turns count. For example, suppose it is desired to resonate the output circuit to an operating frequency of 5.5 MHz and load a 15-foot whip antenna. The proper initial setting for the outer scale TUNE control is indicated on the chart at the intersection of the dashed lines marked TUNE with an imaginary line extending vertically from the 5.5-MHz frequency scale. This value is read on the left- scale (KNOB TURNS) of the chart as 15 (approximately). Similarly, the outer scale LOAD control setting is indicated on the chart at the intersection of the solid curve marked 15 FT LOAD and the imaginary line extending vertically from the 5.5-MHz frequency scale. This value is also read on the left-hand scale of the solid curve that agrees with the length (15, 25, or 45 foot) of the antenna being used, and adjust the outer scale turns count to provide the proper frequency of operation.

WARNING

Do not touch the antenna above the threaded stud during transmission. Serious injury or DEATH could result.

- d. Set the XMTR PWR switch (fig. 3-1) to LO.

CAUTION

Do not allow the XMTR OUTPUT meter needle to peg off-scale; always reduce the deflection slightly by adjusting the M ADJ control counterclockwise. If maximum deflection is not obtained, reset XMTR

PWR switch to OFF for a minute before repeating e below.

e. Immediately adjust the POWER AMPLIFIER TUNE control and then the POWER AMPLIFIER LOAD control to obtain maximum deflection on the XMTR OUTPUT meter. If the antenna being used has a length greater than 15 feet, check for crossover frequencies. A crossover frequency is one where the antenna in use is too long to be properly resonated at the operating frequency and is readily detected by an increase in XMTR OUTPUT meter deflection as the POWER AMPLIFIER LOAD control is rotated to 0.

NOTE

Proper output circuit resonance is normally obtained without rotating the POWER AMPLIFIER TUNE and POWER AMPLIFIER LOAD controls more than 3 turns from the initial setting in c above.

f. Again rotate the POWER AMPLIFIER LOAD and the POWER AMPLIFIER TUNE controls in either direction to obtain a maximum indication on the XMTR OUTPUT meter. Note maximum deflection value.

g. Rotate POWER AMPLIFIER LOAD control clockwise (increasing load) until the indication on the XMTR OUTPUT meter drops one or two divisions.

h. Readjust the POWER AMPLIFIER TUNE control in either direction to obtain a maximum deflection on the XMTR OUTPUT meter. Note the maximum value of deflection.

i. If the maximum indication obtained is greater than the value in f above, repeat g and h above until the absolute maximum value is obtained. If the XMTR OUTPUT meter indication of h above is less than the indication of f above, rotate the POWER AMPLIFIER LOAD control counterclockwise (decreasing load) until the deflection of XMTR OUTPUT meter decreases two or three divisions. Readjust the POWER AMPLIFIER TUNE control in either direction for maximum deflection on the XMTR OUTPUT meter. Repeat until absolute maximum deflection is obtained.

j. Set the XMTR PWR switch to HI and immediately peak the XMTR OUTPUT meter deflection by fine adjustments of the POWER AMPLIFIER LOAD and POWER AMPLIFIER TUNE controls as indicated in f through i above.

k. Return XMTR PWR switch to OFF, and carefully tighten the LOCK knob to secure the turns counters of the POWER AMPLIFIER LOAD and POWER AMPLIFIER TUNE controls.

TM 11-5820-509-12

1 Set the OPR-TUNE switch to OPR and proceed (depending on mode of operation desired) to paragraph 3-7, 3-8, or 3-9.

3-12. Tuning With 50 Ohm Load

- Rotate POWER AMPLIFIER LOAD control (fig. 3-3) to near 0 on outer scale.
- Repeat paragraph 3-11 a, b, and c for POWER AMPLIFIER TUNE control.
- Set XMTR PWR switch (fig. 3-1) to LO.
- Repeat paragraph 3-11e through 1.

3-13. Stopping Procedures

- Set XMTR PWR switch (fig. 3-1) to OFF.
- Set POWER/LIGHTS switch to OFF/OFF.

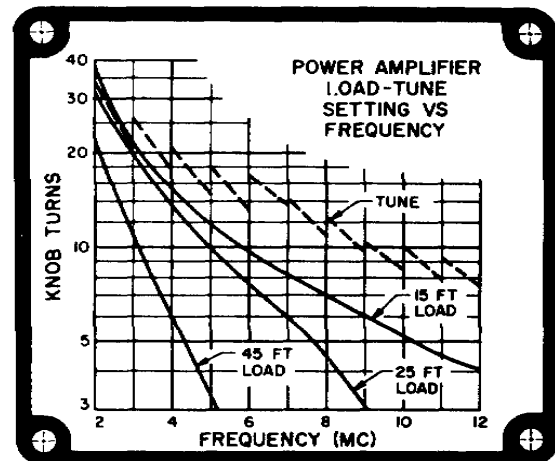

EL5820-509-12-TM-14

Figure 3-2. Power amplifier load-tune chart.

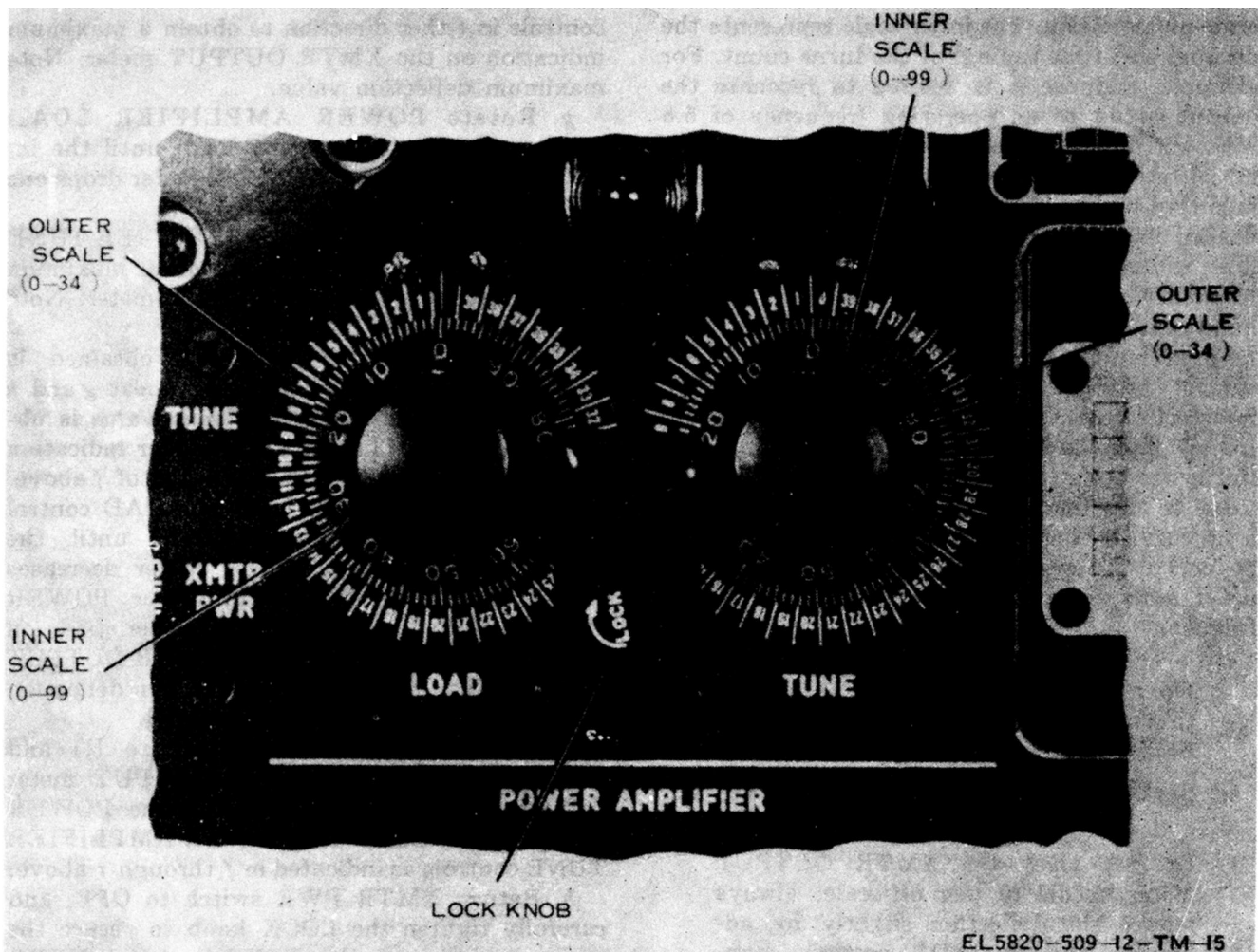

Figure 3-3. Power amplifier load and tune controls.

Section III. OPERATION UNDER UNUSUAL CONDITIONS

3-14. General

Radio Set AN/PRC-47 may be operated in abnormal climatic conditions provided a minimum of precautions are observed to protect the equipment. The following paragraphs discuss operation at extremes of temperature and humidity, during emergency conditions, and in the presence of jamming signals.

3-15. Operation in Extreme Cold

Extreme cold (below -40° F.) will affect the operating efficiency of the receiver-transmitter and can cause mechanical problems with frost buildup on components, brittleness in rubber jacketed conductors, binding at cable connectors, dials, and switches, etc. In addition, electrical difficulties may be experienced in the operation of carbon microphones, charge/discharge rates of batteries, etc. If possible, store the battery in a warm area, but permit the remainder of the equipment to assume the ambient temperature of the environment in which it will be operated.

CAUTION

Operate the transmitter as little as possible in temperatures below -40° F. to preclude the generation of frost on electrical circuits. Replace Cover, Panel CW-647/PRC-47 after each use to keep moisture out of the receiver transmitter.

3-16. Operation in Tropical Conditions

Operation of the equipment in a tropical environment may result in the accumulation of fungi or condensation within the plug-in modules or chassis circuits. Avoid operation where cooled air is permitted to blow over or around the equipment.

CAUTION

Check the internal circuits for fungi accumulation, and remove rust or corrosion from electrical circuits as it becomes apparent.

3-17. Operation in Desert Conditions

The extremely dry, dusty conditions present in desert areas and the abrasiveness of the dust can cause excessive wear in gear trains, bushings, and bearings, can penetrate ventilating openings and stop airflow, and can bridge connectors and terminals causing low-resistance leakage paths during high-humidity periods.

CAUTION

Clean the interior of the equipment often, preferably with a vacuum cleaner

or a low-pressure air jet. Be very careful in cleaning ventilating openings and accumulations that can occur in gear assemblies and bushings. Keep the equipment as clean as possible.

3-18. Emergency Operation

a. Operation During Power Failure. If the primary power source fails during operation from non-battery power, full equipment capability can be maintained by connecting the storage battery to the receiver-transmitter. However, operation with a nearly discharged storage battery is not recommended. Short intervals of receive mode operation can be obtained from a nearly discharged battery, but erratic operation may result, and the transmit mode should not be initiated.

b. Operation During Overtemperature Conditions. Power amplifier tube overtemperature conditions will interrupt transmitter operation. Press the BATTERY TEST pushbutton (fig. 3-1) on the RT-671/PRC-47 front panel to bypass the overtemperature cutout temporarily.

CAUTION

The overtemperature cutout functions whenever the power amplifier tube dissipation limits are exceeded. Recheck the settings of POWER AMPLIFIER LOAD and POWER AMPLIFIER TUNE controls (para 3-11) to assure proper output circuit match between the tube and the connected antenna. Excessive use in periods of unsafe internal temperatures can damage the transmitter circuits.

c. Operation During Radio Silence. When instructed to observe radio silence, the transmitter will not normally be energized. The operator should consult local command directives before attempting such operation. Operation of the receiver circuits for monitoring or broadcast reception is permitted in most instances. If the transmitter must be prepared for operation during periods of radio silence, a dummy load (preferably shielded) should be used to tune and load the circuits to the desired operating frequency.

3-19. Operation During Electronic Jamming

It is possible that the enemy may jam the receive channel during real or simulated tactical operating conditions. Jamming is usually evident by a strong signal on or near the operating frequency which may, or may not, contain

TM 11-5820-509-12

unusual or peculiar forms of modulation. Several forms of electronic jamming are described below to familiarize the operator with the peculiar characteristics of each.

NOTE

Many forms of jamming are used depending upon the tactical value and proximity of the legitimate station. The operator must be aware of the legitimate use of the channel to which he is tuned in order not to confuse legitimate signals with enemy jamming.

a. Continuous-Wave Jamming. Cw jamming is transmitted as a steady carrier that often beats with the desired incoming signal to produce unintelligible transmissions. Random on-off keying of this jamming signal at, or near, the transmission rate of the desired signal may also be employed.

b. Modulated Jamming. Modulated jamming signals may consist of laughter, singing, music, various tones, or noise pulses. Often, more than one of these forms of modulation may be used simultaneously. Some variations of modulated jamming are listed below.

(1) *Spark.* This form is perhaps the simplest, most efficient, and most readily produced jamming signal. It is characterized by a rough, raspy, and somewhat regular form of interference that has no musical properties. The sound is similar to the interference produced by a rotating electric motor with excessive brush spark. This signal is extremely broad and may occupy considerable portions of the spectrum.

(2) *Sweepthrough.* This type of signal is the result of varying an interfering carrier across a band of frequencies at a more or less continuous rate. The sweep rate may vary from quite slow to extremely rapid and is characterized by the generation of many and varied beat notes that sound like a low-flying airplane passing overhead. This type of jamming is effective over a broad range of frequencies and, when the sweep rate is rapid, it has an excellent jamming efficiency against voice signals.

(3) *Stepped tones or "bagpipes".* This type of jamming signal is very distinctive and consists of several separate tones transmitted first in an order of increasing pitch, and then in an order of decreasing pitch. The effect is similar to the sound produced by Scottish bagpipes.

(4) *Random noise.* Jamming by the use of random noise modulation produces a rather broad jamming spectrum. This type of modulation is characterized by a sound similar to the output of a receiver when it is not tuned to an incoming signal.

(5) *Gulls.* This type of jamming signal is characterized by a fast rise and a slow decrease in a variable audio range. The sound produced in the receiver is one that simulates the cry of a sea gull.

(6) *Tone.* This form of jamming employs a single audio tone or one that varies only slightly around a signal frequency. The resulting signal is one that produces a howl.

3-20. Antijamming Techniques

When it has been determined that the incoming signal is being jammed, the operator should notify his immediate supervisor and continue to monitor the incoming signal to the best of his ability. A response to the transmitting station indicating that his signal is being interfered with may result in a different channel selection. Several techniques may be employed by the operator to partially overcome the effects of jamming provided the jamming signal is not too strong.

a. Slightly detune the receiver to either side of the operating frequency to separate the desired signal from the jamming signal if possible.

b. Vary the VOLUME control slightly. This may reduce the intensity of the jamming signal sufficiently to permit reception of the desired signal through the interference.

c. Cw telegraphy is the most efficient mode of transmission in the presence of high-interference levels. A transfer of operations to this mode may be helpful.

CHAPTER 4

OPERATOR AND ORGANIZATIONAL MAINTENANCE

Section I. OPERATOR'S MAINTENANCE

4-1. Scope of Operator's Maintenance

The maintenance duties assigned to the operator of Radio Set AN/PRC-47 are listed below, together with a reference to the paragraphs covering the specific maintenance functions.

- a. Daily preventive maintenance checks and services (para 4-5)
- b. Cleaning (para 4-6).

4-2. Materials Required

- a. Trichloroethane.
- b. Cleaning cloth.
- c. Cleaning brush.

4-3. Operator's Preventive Maintenance

Preventive maintenance is the systematic care, servicing, and inspection of equipment to prevent the occurrence of trouble, to reduce downtime, and to assume that the equipment is serviceable.

a. *Systematic Care.* The procedures given in paragraph 4-4, 4-5, and 4-6 cover routine systematic care and cleaning essential to proper upkeep and operation of the equipment.

b. *Preventive Maintenance Checks and Services.* The preventive maintenance checks and

4-5. Daily Preventive Maintenance Checks and Services Chart

Sequence No.	Item to be inspected	Procedure	Paragraph references
1	Radio set exterior	Inspect for cleanliness	Para 4-6.
2	Electronic components	Inspect for overheating	Higher maintenance category required.
3	Terminals and receptacles	Make sure all cables and connectors are firmly installed.	None.
4	Mounting screws	Inspect for tightness	None.
5	Cables (and battery, if used).	Check for cracks, breaks, and torn insulation	None.

4-6. Cleaning

Inspect the exterior of the equipment. The exterior surfaces should be free of dust, dirt, grease, and fungus.

a. Remove dust and loose dirt with a clean, soft, lint-free cloth.

WARNING

The fumes of trichloroethane are toxic. Provide thorough ventilation whenever used. DO NOT use near an open flame. Trichloroethane is not flammable, but

services chart (para 4-5) outlines functions to be performed daily. These checks and services are to maintain Army electronic equipment in serviceable condition; that is, in good general (physical condition) and in good operating condition. To assist operators in maintaining serviceability, the chart indicates what to check, how to check, and the normal conditions. The Paragraph references column lists the paragraphs that contain detailed repair or replacement procedures. If the defect cannot be remedied by performing the corrective actions indicated, a higher category of maintenance or repair is required. Records and reports of these checks and services must be made in accordance with the requirements set forth in TM 38-750.

4-4. Operator's Preventive Maintenance Checks and Services Periods

Preventive maintenance checks and services of the equipment are required daily or at least once each week if the equipment is maintained in a standby condition. Paragraph 4-5 specifies the items to be checked and serviced.

exposure of the fumes to an open flame converts the fumes to highly toxic, dangerous gases.

b. Remove grease, fungus, and ground-in dirt from the case; use a cloth dampened (not wet) with trichloroethane. After cleaning, wipe dry with a cloth.

CAUTION

Do not press on the face of the meter (glass) when cleaning; the meter may be damaged.

TM 11-5820-509-12

c. Clean the panel, meter, and control knobs; use a soft, clean cloth. If necessary, dampen the

cloth with water; mild soap may be used for more effective cleaning. Wipe dry with a lint-free cloth.

Section II. ORGANIZATIONAL MAINTENANCE

4-7. Scope of Organizational Maintenance

The maintenance duties assigned to the organizational repairman of the radio set are listed below, together with a reference to the paragraphs covering the specific maintenance functions.

- a. Weekly preventive maintenance checks and services 1 para 4-11).
- b. Quarterly preventive maintenance checks and services (para 4-13).
- c. Touchup painting instruction (para 4-14).
- d. Organizational troubleshooting (para 4-16).

4-8. Test Equipment, Tools, and Material Required

The test equipment, tools, and technical manuals for the organizational repairman are listed below.

- a. Tool Kit, Radio Repair TK-101/G.
- b. Multimeter AN/URM-105 (TM 11-6625-203-12).
- c. Fine sandpaper.

4-9. Organizational Maintenance

a. Preventive maintenance is the systematic care, inspection, and servicing of equipment to maintain it in serviceable condition, prevent breakdowns , and assure

maximum operating capability. Preventive maintenance is the responsibility of all maintenance categories concerned with the equipment and includes the inspection, testing, and repair or replacement of parts, subassemblies, or assemblies that inspection and tests indicate would probably fail before the next scheduled periodic service. Preventive maintenance checks and services of the radio set at organizational category are made weekly and quarterly unless otherwise directed by the commanding officer.

b. Maintenance forms and records to be used and maintained on this equipment are specified in TM 38-750.

4-10. Weekly Maintenance

Weekly preventive maintenance checks and services on the radio set are required. Periodic daily services constitute a part of the weekly preventive maintenance checks and services and must be performed concurrently. All deficiencies or shortcomings will be recorded in accordance with the requirements of TM 38-750. Perform all the checks and services listed in the weekly preventive maintenance checks and services chart (para 4-11) in the sequence listed.

4-11. Weekly Preventive Maintenance Checks and Services Chart

Sequence No.	Item to be inspected	Procedures	Paragraph references
1	External hardware.....	See that external hardware is properly tightened.	None.
2	Controls and switches.....	While making operating checks, (sequence No. 3 and 4), observe that mechanical action of each control and switch is smooth and free from binding.	None.
3	Preliminary.....	Repeat paragraph 3-4 except for e.	None.
4	Receiver transmitter performance.	<ul style="list-style-type: none"> a. Set POWER/LIGHTS switch (fig. 3-1; to ON/LO; ob performance serve that panel lamps are dim. Set POWER/LIGHTS switch to ON/HI; observe that panel lamps are brighter. b. Set POWER/LIGHTS switch to ON/LO and press BATTERY TEST pushbutton The XMTR OUTPUT meter indicates in white area. c. Observe that receiver output is obtained in handset. d. Set XMTR PWR switch to LO, press handset push-to-talk switch and speak in a normal voice into handset microphone. Observe that sidetone is heard in handset earphone. e. Set XMTR PWR switch to OFF and set POWER/LIGHTS switch to OFF/OFF. 	<p>(Para 4-16).</p> <p>(Para 2-9).</p> <p>(Para 4-16).</p> <p>(Para 4- 16).</p> <p>N/A.</p>

4-12. Quarterly Maintenance

Quarterly preventive maintenance checks and services on the radio set are required. Periodic daily and weekly services constitute a part of the quarterly preventive maintenance checks and services and must be performed

concurrently. All deficiencies or shortcomings will be recorded in accordance with the requirements of TM 38-750. Perform all the checks and services listed in the

TM 11-5820-509-12

quarterly preventive maintenance checks and services chart (para 3-13) in the sequence listed.

4-13. Quarterly Preventive Maintenance Checks and Services Chart

Sequence No.	Item to be inspected	Procedures	Paragraph references
1	Completeness	See that the equipment is complete.....	(Para 1-1)
2	Spare parts.....	Check all spare parts for general condition and method of storage. There should be no evidence of overstock, and all shortages must be on valid requisitions.	None.
3	Cleanliness	See that the equipment is clean.....	(Para 4-6).
4	Preservation.....	Check all surfaces for evidence of fungus. Remove corrosion	(Para 4-14.).
5	Publications.....	See that all publications are complete, serviceable, and current	DA Pam 310-4.
6	Modifications	Check DA Pam 310-7 to determine if new applicable MWO's have been published. All URGENT MWO's must be applied immediately. All NORMAL MWO's must be scheduled	TM 38-750 and DA Pam 310-7.
7	Connections.....	Check to see that connections are clean and tight.	None.

4-14. Touchup Painting Instruction

Remove rust and corrosion from metal surfaces by lightly sanding them with fine sandpaper. Brush two thin coats of

paint on the bare metal to protect it from further corrosion. Refer to the applicable cleaning and refinishing practices specified in SB 11-573 and TB 746-10.

Section III. ORGANIZATIONAL TROUBLESHOOTING

4-15. General

Troubleshooting of this equipment is based upon the operational checks contained in the weekly preventive maintenance checks and services chart (para. 4-11). To troubleshoot the equipment, proceed until an abnormal condition or result is observed. When an abnormal

condition or result is observed, perform the corrective measures indicated in the Checks and corrective measures column. If the corrective measures indicated do not result in correction of the trouble, a higher category of maintenance is required.

4-16. Organizational Troubleshooting Chart

Item No.	Trouble symptom output.	Probable trouble	Checks and corrective measures
1	Panel lamps do not light	a. Defective fuse. b. Lamps burned out.	a. Replace appropriate fuse (ac or dc)(para 4-17a). b. Replace appropriate lamps (para 4-17b or c).
2	Radio set does not energize	a. Power cable not properly connected. b. Defective battery. c. Defective power source.	a. Check cable connection. b. Check battery (para 2-9a). c. Check power source (para 2-9b or c).
3	No audio in headset	a. VOLUME control set too low. b. Defective receiving apparatus.	a. Adjust VOLUME control. b. Replace apparatus {handset, headset, or loudspeaker).
4	Weak or no receive output	a. Antenna improperly installed. b. Discharged battery.	a. Check connection at ANTENNA receptacle. b. Check battery (para 2-9a).
5	Weak or no transmit output	a. Defective handset or key. b. Discharged battery. c. Transmitter improperly tuned.	a. Check handset or key b. Check battery (para 2-9a). c. Tune transmitter (para 3-6).

4-17. Removal and Replacement

Procedures

Remove and replace lamps and fuses (fig. 3-1), using the following procedures:

a. *Fuses.* Replace the POWER 5A AC or 20A DC fuses in the holders on the front of the RT-671/PRC-47 as follows:

(1) Turn the fuseholder cap a quarter turn counterclockwise.

(2) Remove the fuseholder cap and the fuse from the holder.

(3) Replace the defective fuse with a new applicable fuse (5 amp or 20 amp) in the fuseholder.
(4) Replace the fuseholder cap in the receptacle and turn a quarter turn clockwise.

b. *Lamps*

(1) Unscrew the lampholder cap by turning it counterclockwise.

(2) Pull the lamp out of the holder.

(3) Insert a replacement lamp in the holder.

(4) Replace the lampholder cap by turning it clockwise into the receptacle.

APPENDIX A

REFERENCES

DA Pam 310-4	Index of Technical Manuals, Technical Bulletins, Supply Manuals (Types 7, 8, and 9), Supply Bulletins, and Lubrication Orders.
DA Pam 310-7	U. S. Army Equipment Index of Modification Work Orders.
SB 11-131	Vehicular Radio Sets and Authorized Installations.
SB 11-573	Painting and Preservation Supplies Available for Field Use for Electronics Command Equipment.
TB 746-10	Field Instructions for Painting and Preserving Electronics Command Equipment.
TB SIG 291	Safety Measures to be Observed when Installing and Using Whip Antennas, Field Type Masts, Towers, Antennas, and Metal Poles that are Used with Communication, Radar, and Direction Finder Equipment.
TM11-5038	Control Group AN/GRA-6.
TM11-5820-527-15	Operator, Organizational, Direct and General Support and Depot Maintenance Manual: Radio Set AN/TRC-75.
TM11-6140-208-15	Organizational, DS, GS, and Depot Maintenance Manual Including Repair Parts and Special Tool Lists: Battery, Storage BB-451/U.
TM11-6625-203-12	Operator and Organizational Maintenance Manual: Multimeter AN/URM-105, Including Multimeter ME-77/U.
TM 38-750	The Army Maintenance Management Systems (TAMMS).
TM 740-90-1	Administrative Storage of Equipment.
TM 750-244-2	Procedures for Destruction of Electronics Materiel to Prevent Enemy Use (Electronics Command).

APPENDIX B

BASIC ISSUE ITEMS LIST AND ITEMS TROOP INSTALLED OR AUTHORIZED LIST

AND ORGANIZATIONAL MAINTENANCE REPAIR PARTS AND SPECIAL TOOLS LIST

Section I. INTRODUCTION

B-1. Scope.

This appendix lists basic items; items troop installed or authorized; repair parts; and special tools required for the operation and performance of organizational maintenance of Radio Set AN /PRC-47.

B-2. General

This Basic Issues Items, Items Troop Installed or Authorized, Repair Parts and Special Tools List is divided into the following sections:

- a. *Section II - Basic Issue Items List.* Not applicable.
- b. *Section III - Items Troop Installed or authorized List.* Not applicable.
- c. *Section IV - Repair Parts List.* A list of repair parts authorized for use in the performance of maintenance. The list also includes parts which must be removed for replacement of the authorized parts.
- d. *Section V - Special Tools List.* Not applicable.
- e. *Section VI - Federal Stock Number and Part Number Index.* Not applicable.

B-3 Explanation of Columns .

The following provides an explanation of columns found in the tabular listings:

- a. *Illustration.* This column is divided as follows:
 - (1) *Figure number.* Indicates the figure number of the illustration in which the item is shown.
 - (2) *Item number.* The number used to identify each item called out in the illustration.
- b. *Source, Maintenance, and Recoverability Codes [SMR].*
 - (1) *Source code.* Source codes are assigned to support items to indicate the manner of acquiring support items for maintenance, repair, or overhaul of end items. Source codes are entered in the first and second positions of the Uniform SMR Code format as follows:

<i>Code</i>	<i>Definition</i>
PA	Item procured and stocked for anticipated or known usage.

NOTE

Cannibalization or salvage may be used as a source of supply for any items source coded above except those coded XA, XD, and aircraft support items as restricted by AR 700-42.

(2) *Maintenance code.* Maintenance codes are assigned to indicate the levels of maintenance authorized to USE and REPAIR support items. The maintenance codes are entered in the third and fourth positions of the Uniform SMR Code format as follows:

(a) The maintenance code entered in the third position will indicate the lowest maintenance level authorized to remove, replace, and use the support item. The maintenance code entered in the third position will indicate one of the following levels of maintenance:

<i>Code</i>	<i>Application/explanation</i>
0	Support item is removed, replaced, used at the organizational level.

(b) The maintenance code entered in the fourth position indicates whether the item is to be repaired and identifies the lowest maintenance level with the capability to perform complete repair (i.e., all authorized maintenance functions). This position contains the following maintenance code:

<i>Code</i>	<i>Application/explanation</i>
Z	Nonreparable. No repair is authorized.

(3) *Recoverability code.* Recoverability codes are assigned to support items to indicate the disposition action on unserviceable items. The recoverability code is entered in the fifth position of the Uniform SMR Code format as follows:

<i>Recoverability Codes</i>	<i>Definition</i>
Z	Nonreparable item. When unserviceable, condemn and dispose at the level indicated in position 3.

c. *Federal Stock Number.* Indicates the Federal stock number assigned to the item and

TM 11-5820-509-12

will be used for requisitioning purposes.

d. Part Number. Indicates the primary number used by the manufacturer (individual, company, firm, corporation, or Government activity), which controls the design and characteristics of the item by means of its engineering drawings, specifications standards, and inspection requirements, to identify an item or range of items.

NOTE

When a stock numbered item is requisitioned, the repair part received may have a different part number than the part being replaced.

e. Federal Supply Code for Manufacturer [FSCM]. The FSCM is a 5-digit numeric code listed in SB-708-42 which is used to identify the manufacturer, distributor, or Government agency, etc.

f. Description. Indicates the Federal item name and, if required, a minimum description to identify the item.

g. Unit of Measure U/MJ. Indicates the standard of the basic quantity of the listed item as used in performing the actual maintenance function. This measure is expressed by a two- alphabetical abbreviation (e.g., ea. in, pr, etc.). When the unit of measure differs from the unit of issue, the lowest unit of issue that will satisfy the required units of measure will be requisitioned .

h. Quantity Incorporated in Unit. Indicates the quantity of the item used in the breakout shown on the illustration figure, which is prepared for an assembly.

B-4. Special Information

Not applicable.

B-5. How to Locate Repair Parts

Not applicable.

B-6. Abbreviations

Not applicable.

SECTION IV. REPAIR PARTS LIST

(1) ILLUSTRATION (A) (B) FIG ITEM NO. NO.		(2) SMR CODE	(3) FEDERAL STOCK NUMBER	(4) PART NUMBER	(5) FSCM	(6) DESCRIPTION <i>USABLE ON CODE</i>	(7) UNIT OF MEAS	(8) QTY INC IN UNIT
B-1	1	PAOZZ	5920-280-3562	FO3A125V20AS	81349	RADIO SET AN/PRC-47 FUSE CARTRIDGE	EA	1
B-1	2	PAOZZ	5920-060-2424	FO3A250V5AS	81349	FUSE CARTRIDGE	EA	1
B-1	3	PAOZZ	6240-155-7836	MS25237-387	96906	LAMP, INCANDESCENT	EA	4

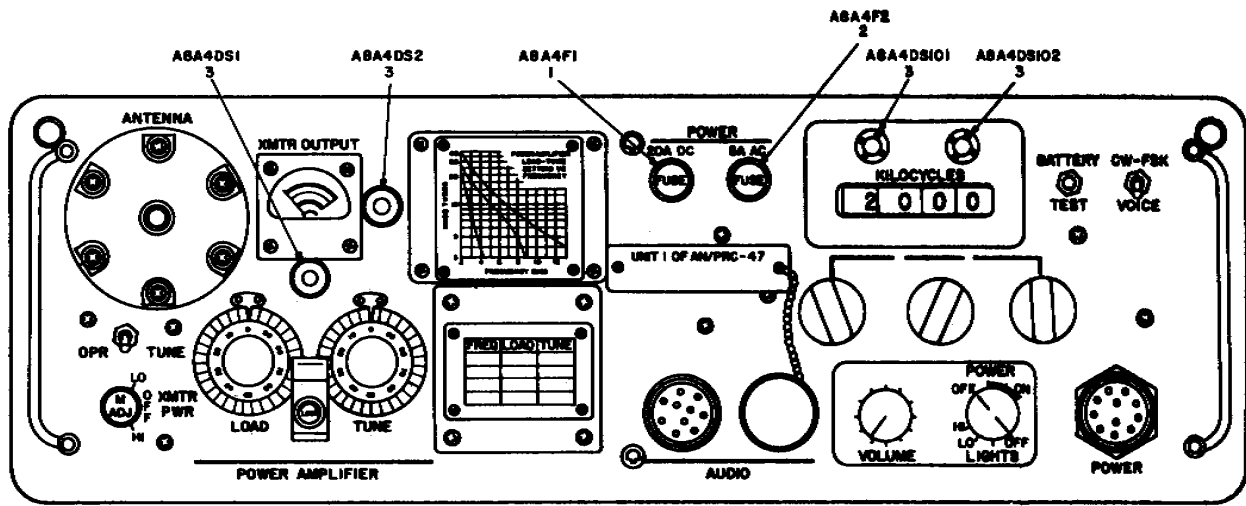

EL5820-509-12-TM-23

Figure B-1. Receiver-Transmitter, Radio RT-671/PRC -4 7, parts location.

APPENDIX C

MAINTENANCE ALLOCATION

Section I. INTRODUCTION

C-1. General

This appendix provides a summary of the maintenance operations covered in the equipment literature. It authorizes categories of maintenance for specific maintenance functions on repairable items and components and the tools and equipment required to perform each function. This appendix may be used as an aid in planning maintenance operations.

C-2. Maintenance Functions

Maintenance functions will be limited to and defined as follows:

a. Inspect. To determine the serviceability of an item by comparing its physical, mechanical, and/or electrical characteristics with established standards through examination.

b. Test. To verify serviceability and to detect incipient failure of measuring the mechanical or electrical characteristics of an item and comparing those characteristics with prescribed standards.

c. Service. Operations required periodically to keep an item in proper operating condition, i.e., to clean, preserve, drain, paint, or to replenish fuel/lubricants/hydraulic fluids or compressed air supplies.

d. Adjust. Maintain within prescribed limits by bringing into proper or exact position, or by setting the operating characteristics to the specified parameters.

e. Align. To adjust specified variable elements of an item to about optimum or desired performance.

f. Calibrate. To determine and cause corrections to be made or to be adjusted on instruments or test measuring and diagnostic equipment used to precision measurement. Consists of the comparison of two instruments, one of which is a certified standard of known accuracy, to detect and adjust any discrepancy in the accuracy of the instrument being compared.

g. Install. The act of emplacing, seating, or fixing into position an item, part, module (component or assembly) in a manner to allow the proper functioning of the equipment/system.

h. Replace. The act of substituting a serviceable like-type part, subassembly, module (component or assembly) in a manner to allow the proper functioning of an equipment/system.

i. Repair. The application of maintenance services (inspect, test, service, adjust, align, calibrate, replace) or other maintenance actions (welding, grinding, riveting, straightening, facing, remachining, or resurfacing) to restore serviceability to an item by correcting specific damage, fault, malfunction, or failure in a part, subassembly, module/component/assembly, end item or system.

j. Overhaul. That maintenance effort (service necessary to restore an item to a completely serviceable/operational condition as prescribed by maintenance standards (e.g., DMWR) in pertinent technical manuals. Overhaul is normally the highest degree of maintenance performed by the Army. Overhaul does not normally return an item to like-new condition.

k. Rebuild. Consists of those services/actions necessary for the restoration of unserviceable equipment to a like-new condition in accordance with original manufacturing standards. Rebuild is the highest degree of materiel maintenance applied to Army equipment. The rebuild operation includes the act of returning to zero those age measurements {hours, miles, etc.) considered in classifying Army equipment/components.

l. Symbols. The uppercase letter placed in the appropriate column indicates the lowest level at which that particular maintenance function is to be performed.

C-3. Explanation of Format

a. Group Number. Column 1 lists group numbers, the purpose of which is to match components, assemblies, subassemblies and modules with the next higher assembly.

b. Functional Group. Column 2 lists the next higher assembly group and the item names of components, assemblies, subassemblies and modules within the group for which maintenance is authorized.

c. Maintenance Functions. Column 3 lists the twelve maintenance functions defined in C-2

TM 11-5820-509-12

above. Each maintenance function required for an item is specified by the symbol among those listed in below which indicates the level responsible for the required maintenance. Under this symbol is listed an appropriate work measurement time value determined as indicated in *e* below.

d. Use of Symbols. The following symbols are used to prescribe work function responsibility:

C..... Operator/Crew
O..... Organization
F..... Direct Support
H..... General Support
D..... Depot

e. Work Measurement Time. The active repair time required to perform the maintenance function is included directly below the symbol identifying the category of maintenance. The skill levels used to obtain the measurement times approximate those found in typical TOE units. Active repair time is the average aggregate time required to restore an item (subassembly, assembly, component, module, end item or system) to a serviceable condition under typical field operating conditions. This time includes preparation time, fault isolation/diagnostic time, and QA/QC time in addition to the time required to perform specific maintenance functions identified for the tasks authorized in the maintenance allocation chart.

This time is expressed in man-hours and carried to one decimal place (tenths of hours).

f. Tools and Test Equipment. This column is used to specify, by code, those tools and test equipment required to perform the designated function.

g. Remarks. Self-explanatory.

C-4. Explanation of Format of Table I and Test Equipment Requirements

The columns in table I follows:

a. Tools and Equipment. The numbers in this column coincide with the numbers used in the tools and equipment column of the maintenance allocation chart. The numbers indicate the applicable tool for the maintenance function.

b. Maintenance Category. The codes in this column indicate the maintenance category normally allocated the facility.

c. Nomenclature. This column lists tools, test, and maintenance equipment required to perform the maintenance functions.

d. Federal Stock Number. This column lists the Federal stock number of the specific tool or test equipment.

e. Tool Number. Not used.

TM 11-5820-509-12

TABLE I. TOOL AND TEST EQUIPMENT REQUIREMENTS

TOOLS AND EQUIPMENT	MAINTENANCE CATEGORY	NOMENCLATURE	FEDERAL STOCK NUMBER	TOOL NUMBER
1	F,H,D	MULTISETTER ME-26/U	6665-360-2493	
2	F, H,D	METER, AUDIO LEVEL TS-595/U	6625-244-0501	
3	F, H,D	GENERATOR, SIGNAL SG-103/URM-25	6625-510-1827	
4	F, H, D	FREQUENCY METER AN/URM-79	6625-668-9749	
5	F, H, D	DUMMY LOAD, ELECTRICAL DA-75/U	5985-280-3480	
6	F,H,D	AUDIO OSCILLATOR TS-382()	6625-192-5094	
7	F, H, D	OSCILLOSCOPE AN/USM-231A	6625-228-2201	
8	H, D	TOOL KIT, ELECTRONIC REPAIRMAN TK-100/G	5180-605-0079	
9	H, D	ANALYZER, SPECTRUM TS-723 ()	6625-668-9418	
10	H, D	MULTIMETER TS-325B/U	6625-242-5023	
11	D	ANALYZER, SPECTRUM AN/UPM-110	6625-720-2495	
12	D	DOWN CONVERTOR,HEWLETT PACKARD K15-8551D (FOR USE WITH AN/UPM-110)		
13	D	TEST SET FOR : AM-3506/PRC-47 AM-3507/PRC-47 CV-1377A/PRC-47 PP-3518/PRC-47 O-1-32/PRC-47 C-4311/PRC-47		
14	D	POWER SUPPLY PP-3940/G	6130-985-8136	
15	D	POWER SUPPLY PP-3941/G	6130-985-8143	
16	D	AMMETER ME-156/U	6625-620-1405	
17	D	RESISTANCE SUBSTITUTION DECADE BOX MX-3991/U		
18	H,D	VOLTMETER, VACUUM TUBE ME-30-/U	6625-669-0742	
19	D	RECEIVER R-1433/URR		
20	D	RADIO SET AN/PRC-47	5820-861-3539	

TM 11-5820-509-12

By Order of the Secretary of the Army:

CREIGHTON W. ABRAMS
General, United States Army
Chief of Staff

Official:

VERNE L. BOWERS
Major General, United States
The Adjutant General

Distribution:

To be distributed in accordance with DA Form 12-51, (qty rqr block No. 338) Organizational maintenance requirements for AN/PRC-47.

*U. S. GOVERNMENT PRINTING OFFICE: 1985 O - 491-202 (20485)

RECOMMENDED CHANGES TO EQUIPMENT TECHNICAL PUBLICATIONS



THEN...JOT DOWN THE DOPE ABOUT IT ON THIS FORM. CAREFULLY TEAR IT OUT, FOLD IT AND DROP IT IN THE MAIL.

SOMETHING WRONG WITH PUBLICATION

FROM: (PRINT YOUR UNIT'S COMPLETE ADDRESS)

DATE SENT

PUBLICATION NUMBER

PUBLICATION DATE

PUBLICATION TITLE

BE EXACT PIN-POINT WHERE IT IS

PAGE NO.	PARA-GRAPH	FIGURE NO.	TABLE NO.
----------	------------	------------	-----------

IN THIS SPACE, TELL WHAT IS WRONG AND WHAT SHOULD BE DONE ABOUT IT.

TEAR ALONG PERFORATED LINE

PRINTED NAME, GRADE OR TITLE AND TELEPHONE NUMBER

SIGN HERE